



Companies within  
the Atlas Copco Group

*Sales Contacts:*

- **Asia, Australia,  
New Zealand, Japan**  
telephone (852) 235 70 963  
facsimile (852) 276 31 875
- **Austria**  
telephone (43) 2246 4677  
facsimile (43) 2246 4682
- **Belgium, Luxembourg**  
telephone (32) 2 660 4938  
facsimile (32) 2 672 6092
- **France**  
telephone (33) 2 40 80 20 00  
facsimile (33) 2 40 33 27 07
- **Germany**  
telephone (49) 6181 4110  
facsimile (49) 6181 411184
- **International**  
telephone (44) 1442 344 300  
facsimile (44) 1442 344 602
- **Italy**  
telephone (39) 039 244 101  
facsimile (39) 039 465 5025
- **Netherlands**  
telephone (31) 765 878 668  
facsimile (31) 765 878 825
- **Portugal**  
telephone (35) 11 3158792  
facsimile (35) 11 3158793
- **South Africa**  
telephone (27) 11 821 9300  
facsimile (27) 11 821 9360
- **Spain**  
telephone (34) 91 590 3152  
facsimile (34) 91 590 3161
- **United Kingdom**  
telephone (44) 1442 344 301  
facsimile (44) 1442 344 600
- **U.S.A., Canada and Mexico**  
telephone (1) 800 867 2442  
facsimile (1) 800 232 6611

# Accessories

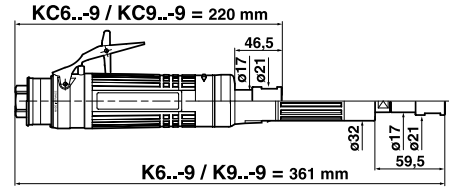
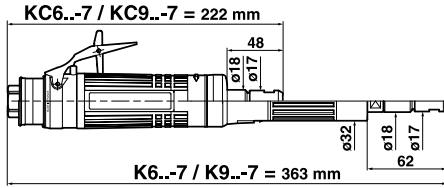

## K6..- / K9..- / KC6..- / KC9..-

### ACCESSORIES INCLUDED

ITEM	COLLET CNOMO	COLLET SERIES 200
1 CNOMO collet $\varnothing$ 6 mm	615 526 049 0	
2 Series 200 resilient collet, $\varnothing$ 5.55 to 6.35 mm (1/4")		615 526 063 0
• Exhaust hose L = 1.5 m (60")	615 875 113 0	615 875 113 0
• Clamp	615 873 415 0	615 873 415 0
• 3/8" air hose nipple for 10 mm ID hose	615 704 017 0	615 704 017 0
• Flat wrench 14 mm	615 801 005 0	615 801 005 0
• Flat wrench 19 mm (3/4")		615 801 076 0

### OPTIONAL ACCESSORIES

ITEM	K6..-/K9..-	KC6..-/KC9..-
3 Suction cap		615 396 013 0
4 Suction cap		615 396 023 0
5 Suction cap	615 396 014 0	
6 Diamond burr $\varnothing$ 7.2 mm, shank $\varnothing$ 6 mm (28 000 rpm max)	615 860 051 0	615 860 051 0
7 Diamond cylinder $\varnothing$ 27 mm, shank $\varnothing$ 6 mm (20 000 rpm max)	615 860 003 0	615 860 003 0
8 Diamond cylinder $\varnothing$ 52 mm, shank $\varnothing$ 6 mm (15 000 rpm max)		615 860 004 0

### OTHER OPTIONAL ACCESSORIES

ITEM	PART NO.
9 Complete silencer kit	615 396 166 0
10 Inlet hose assembly L = 1.7 m (67") 3/8"M - 3/8"F - $\varnothing$ 10 mm	615 870 210 0
11 Reinforced cloth-lined exhaust hose L = 0.75 m (30")	615 875 116 0

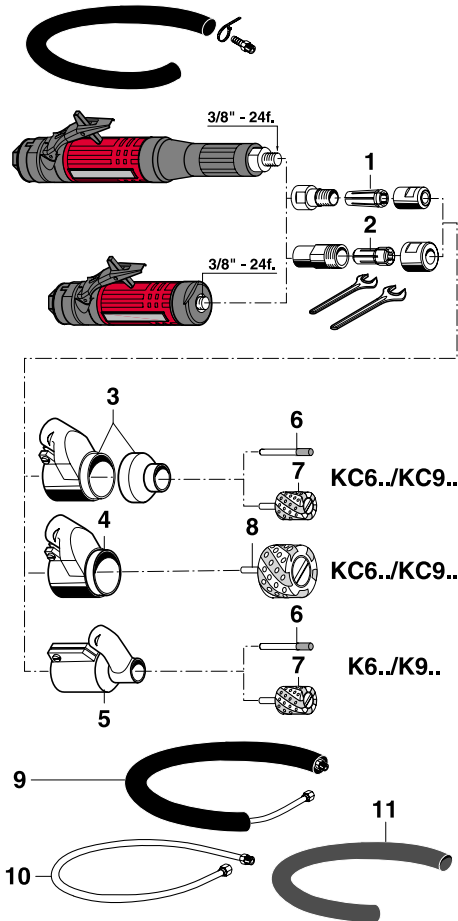

**Lou Zampini & Associates**  
 2 Douglas Pike, Rt. 7  
 Smithfield, RI 02917  
 1 800 353 4676  
 FAX 1 401 679 0165



# Dust extraction systems for straight grinders

600 - 900 Watts (0.8 - 1.21 hp) - 12 000 to 28 000 rpm



A

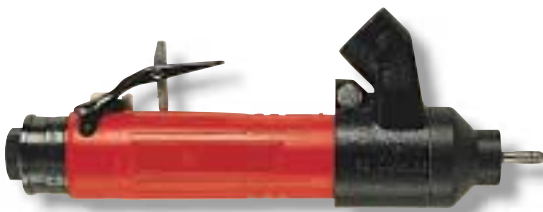

B



B



615 396 014 0  
Vacuum hose,  
ID 25 mm  
(1")



615 396 013 0  
Vacuum hose,  
ID 32 mm  
(1-1/4")



615 396 023 0  
Vacuum hose,  
ID 32 mm  
(1-1/4")

Caution: comply with the speeds recommended by component and abrasive manufacturers

PICTURE REF	MODEL	PART NUMBER		SUCTION CAP ASSEMBLY	FREE SPEED	POWER		WEIGHT		AIR INLET THREAD	
		CNOMO COLLET (-7)	SERIES 200 COLLET (-9)			W	hp	kg	lb.		
						rpm				inch	
A	K628-	615 170 107 0	615 170 150 0	+	615 396 014 0	28 000	600	0.80	1.3	2.9	3/8
A	K624-	615 170 106 0	615 170 151 0	+	615 396 014 0	24 000	600	0.80	1.3	2.9	3/8
A	K922-	615 170 119 0	615 170 152 0	+	615 396 014 0	22 000	900	1.21	1.4	3.1	3/8
A	K619-	615 170 105 0	615 170 153 0	+	615 396 014 0	19 000	600	0.80	1.3	2.9	3/8
A	K918-	615 170 117 0	615 170 154 0	+	615 396 014 0	18 000	900	1.21	1.4	3.1	3/8
A	K615-	615 170 104 0	615 170 155 0	+	615 396 014 0	15 000	600	0.80	1.3	2.9	3/8
A	K915-	615 170 114 0	615 170 156 0	+	615 396 014 0	15 000	900	1.21	1.4	3.1	3/8
A	K912-	615 170 110 0	615 170 157 0	+	615 396 014 0	12 000	900	1.21	1.4	3.1	3/8
B	KC628-	615 170 126 0	615 170 158 0	+	615 396 013 0 or 615 396 023 0	28 000	600	0.80	0.9	2.0	3/8
B	KC624-	615 170 125 0	615 170 159 0	+	615 396 013 0 or 615 396 023 0	24 000	600	0.80	0.9	2.0	3/8
B	KC922-	615 170 130 0	615 170 160 0	+	615 396 013 0 or 615 396 023 0	22 000	900	1.21	1.0	2.2	3/8
B	KC619-	615 170 124 0	615 170 161 0	+	615 396 013 0 or 615 396 023 0	19 000	600	0.80	0.9	2.0	3/8
B	KC918-	615 170 129 0	615 170 162 0	+	615 396 013 0 or 615 396 023 0	18 000	900	1.21	1.0	2.2	3/8
B	KC615-	615 170 123 0	615 170 163 0	+	615 396 013 0 or 615 396 023 0	15 000	600	0.80	0.9	2.0	3/8
B	KC915-	615 170 128 0	615 170 164 0	+	615 396 013 0 or 615 396 023 0	15 000	900	1.21	1.0	2.2	3/8
B	KC912-	615 170 127 0	615 170 165 0	+	615 396 013 0 or 615 396 023 0	12 000	900	1.21	1.0	2.2	3/8



# Accessories

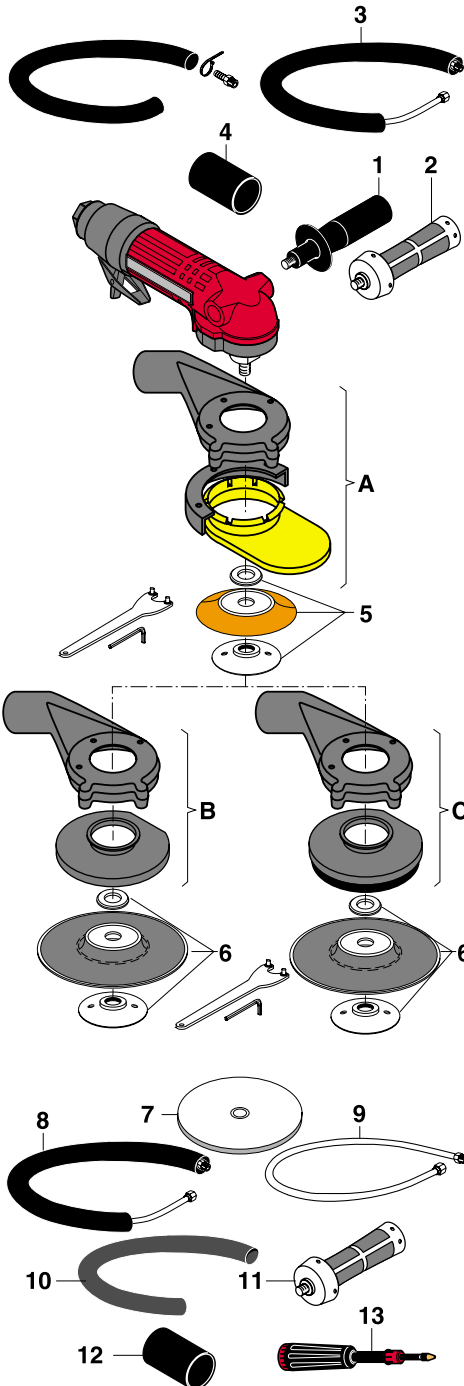
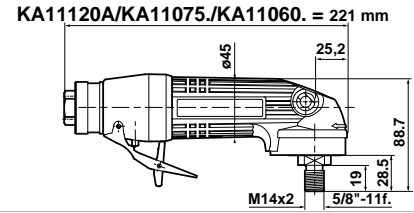
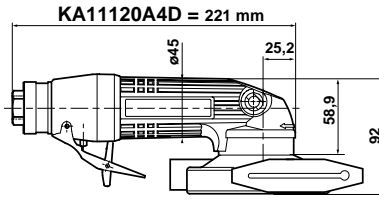
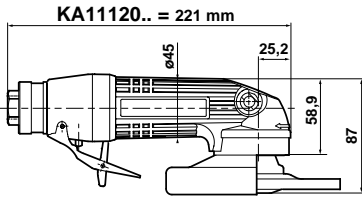

## KA11120.5K / KA11120A. / KA11120B5. / KA11075. / KA11060.

### ACCESSORIES INCLUDED

ITEM	KA11120A.	
	KA11120H5K	KA11120B5.
• Exhaust hose L = 1.5 m (60")		615 875 1130
• Clamp		615 873 415 0
• 3/8" air hose nipple for 13 mm ID hose		615 704 027 0
1 Side handle		615 576 038 0
2 Vibration-damping side handle	615 576 066 0	
3 Complete silencer kit	615 396 166 0	
4 Thermal insulating sleeve	615 570 412 0	

Grinders are supplied with their flanges, wheel guards and service keys

### OPTIONAL ACCESSORIES

ITEM	For grinding or sanding with semirigid disc for metallic materials	
	KA11120A5K	KA11120H5K KA11120A5.
A Suction cap for grinding wheel and semirigid disc ø 127 mm (5")	615 396 009 0	615 396 009 0
5 Backing pad with nut M14 (max: 12 000 rpm)*	615 990 129 0	

\* Sanding with semirigid disc

ITEM	For sanding metallic materials	
	KA11120A	KA110..A / B
B Suction cap for standard abrasive disc ø 127 mm (5")	615 396 010 0	
6 Ventilated backing pad with nut M14 and 5/8" (max: 12 000 rpm)	615 990 127 0	

ITEM	For sanding non metallic materials	
	KA11120A	KA110..A / B
C Suction cap for standard abrasive disc ø 127 mm (5")	615 396 012 0	
6 Ventilated backing pad with nut M14 and 5/8" (max: 12 000 rpm)	615 990 127 0	

### OTHER OPTIONAL ACCESSORIES

ITEM	PART NO.
7 Diamond disc ø 100 mm (4")	615 860 002 0
8 Complete silencer kit	615 396 166 0
9 Inlet hose assembly L = 1.7 m (67") 3/8"M - 3/8"F - ø 13 mm	615 804 064 0
10 Reinforced cloth-lined exhaust hose L = 0.75 m (30")	615 875 116 0
11 Vibration-damping side handle	615 576 066 0
12 Thermal insulating sleeve	615 570 412 0
13 Grease gun (capacity 24 g.)	615 990 149 0
• Lubricant for bevel gear (1 kg)	615 990 148 0



# Dust extraction systems for angle grinders and sanders Ø 100 mm (4") - Ø 127 mm (5")

900 to 1 100 Watts (1.21 to 1.5 hp) - 6 000 to 12 000 rpm



A

Adjustable lever



B

Dust extraction casing for diamond disc Ø 100 mm (4")  
Vacuum hose ID 25 mm (1")

For wheel or  
semirigid abrasive  
Metallic materials

For standard  
abrasive disc  
Metallic materials

For standard  
abrasive disc  
Non metallic materials



615 396 009 0



615 396 010 0



615 396 012 0

Vacuum hose, ID 38 mm (1-1/2")



C

Caution: comply with the speeds recommended by component and abrasive manufacturers

PICTURE REF	MODEL	PART NUMBER	SUCTION CAP ASSEMBLY	FREE SPEED rpm	THREADED SPINDLE	POWER		WEIGHT		AIR INLET THREAD inch
						W	hp	kg	lb.	
<b>ANGLE GRINDERS</b>										
A	KA11120H5K	615 170 028 0	+ 615 396 009 0	12000	HEX	1100	150	1.7	3.7	3/8
A	KA11120A5K	615 170 054 0	+ 615 396 009 0	12000	M14x2	1100	150	1.7	3.7	3/8
A	KA11120A5	615 170 053 0	+ 615 396 009 0	12000	M14x2	1100	150	1.7	3.7	3/8
A	KA11120B5	615 170 056 0	+ 615 396 009 0	12000	5/8"-11f.	1100	150	1.7	3.7	3/8
A	KA11120A5F	615 170 052 0	+ 615 396 009 0	12000	M14x2	1100	150	1.7	3.7	3/8
A	KA11120B5F	615 170 055 0	+ 615 396 009 0	12000	5/8"-11f.	1100	150	1.7	3.7	3/8
B	KA11120A4D	615 170 059 0	Supplied with dust extraction casing	12000	M14x2	1100	150	2.0	4.4	3/8
<b>ANGLE SANDERS</b>										
C	KA11120A	615 170 051 0	+ 615 396 010 0 or 615 396 012 0	12000	M14x2	1100	150	1.4	3.1	3/8
C	KA11075A	615 170 061 0	+ 615 396 010 0 or 615 396 012 0	7500	M14x2	1000	134	1.4	3.1	3/8
C	KA11075B	615 170 062 0	+ 615 396 010 0 or 615 396 012 0	7500	5/8"-11f.	1000	134	1.4	3.1	3/8
C	KA11060A	615 170 063 0	+ 615 396 010 0 or 615 396 012 0	6000	M14x2	900	121	1.4	3.1	3/8
C	KA11060B	615 170 064 0	+ 615 396 010 0 or 615 396 012 0	6000	5/8"-11f.	900	121	1.4	3.1	3/8



# Accessories

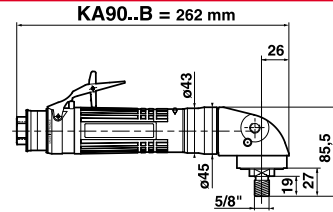
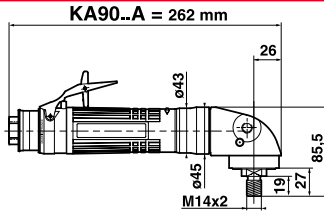
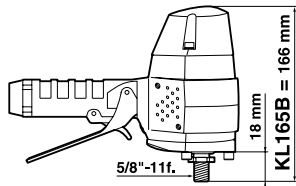

## KL165B / KA90..A / KA90..B

### ACCESSORIES INCLUDED

	KL165B	KA90..A	KA90..B
• Rear flange	615 503 107 0		
• 1/2" air hose nipple for 13 mm ID hose	615 704 016 0		
• Exhaust hose L = 1.5 m (60")		615 875 113 0	
• Clamp		615 873 415 0	
• 3/8" air hose nipple for 10 mm ID hose		615 704 017 0	
• Grip		615 576 069 0	

### OPTIONAL ACCESSORIES

For sanding:	KL165B	KL165B
	non metallic materials Fibre disc	metallic materials Fibre disc
• Complete kit (including Item 1-2-3)	615 399 364 0	615 399 365 0
1 Assembled dust collector	615 399 359 0	615 399 360 0
2 Washer Z16U	615 642 050 0	615 642 050 0
3 Rigid backing pad with nut (max: 8500 rpm)	615 990 134 0	615 990 134 0
• Pin wrench, 35 mm (1-3/8")	615 802 010 0	615 802 010 0
• Hex. key 8 mm (5/16")	615 802 061 0	615 802 061 0

For sanding metallic materials	KA90..A / B
ITEM	Ø 180 mm (7")
A Suction cap	615 396 125 0
4 Rigid backing pad with nut M14 and 5/8" Ø 180 mm (7") (max: 8 500 rpm)	615 990 134 0
• Pin wrench, 35 mm (1-3/8")	615 802 010 0

For sanding non metallic materials	KA90..A / B
ITEM	Ø 180 mm (7")
B Suction cap	615 396 126 0
4 Rigid backing pad with nut M14 and 5/8" Ø 180 mm (7") (max: 8 500 rpm)	615 990 134 0
• Pin wrench, 35 mm (1-3/8")	615 802 010 0

### OTHER OPTIONAL ACCESSORIES

ITEM	KL165B	KA90..A	KA90..B
C Silencer kit	615 396 117 0		
D Silencer kit	615 399 462 0		
5 Complete silencer kit		615 396 166 0	
6 Inlet hose assembly L = 1.7 m (67") 3/8"M - 3/8"F Ø 10 mm		615 870 210 0	
7 Reinforced cloth-lined exhaust hose L = 0.75 m (30")		615 875 116 0	
8 Vibration-damping side handle		615 576 066 0	

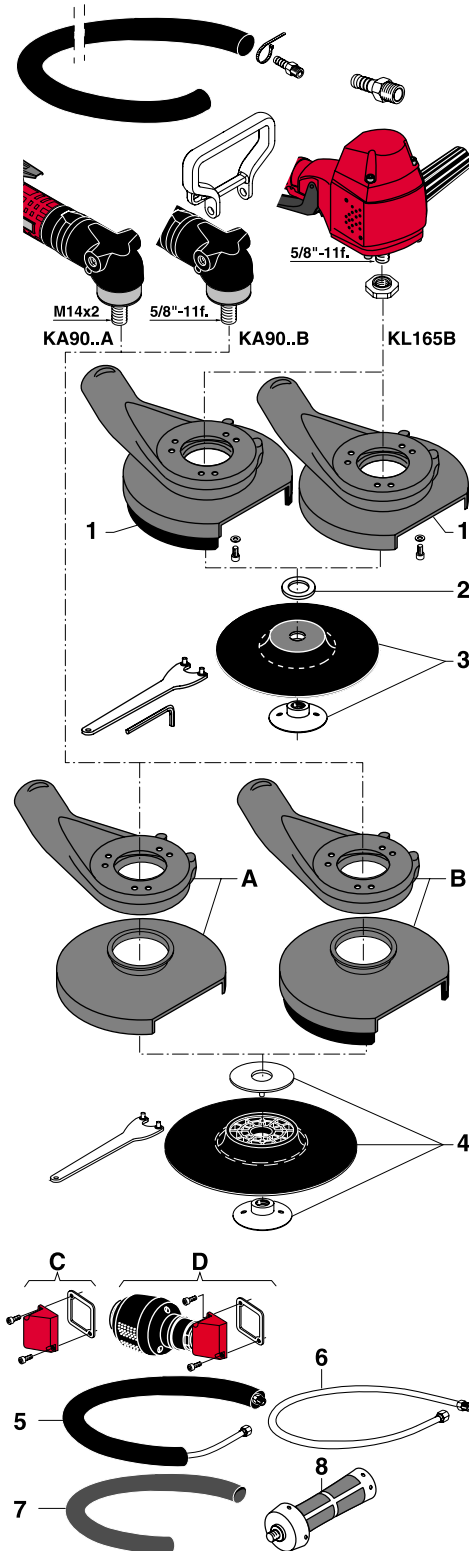

# Dust extraction systems for vertical and angle sanders Ø 180 mm (7")

900 - 1 200 Watts (1.21 - 1.61 hp) - 2 000 to 6 500 rpm

Supplied with M14 or 5/8" threaded spindle only



A



B

For standard abrasive disc for non metallic materials

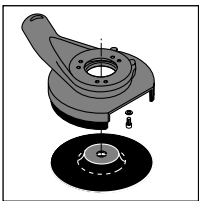

615 399 364 0

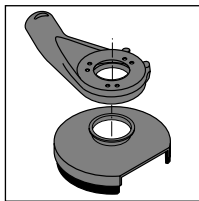

615 396 126 0

For standard abrasive disc for metallic materials

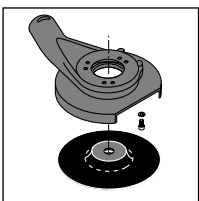

615 399 365 0

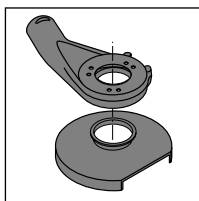

615 396 125 0

Vacuum hose, ID 38 mm (1-1/2")



B

Caution: comply with the speeds recommended by component and abrasive manufacturers

PICTURE REF	MODEL	PART NUMBER	DUST EXTRACTION KIT	FREE	THREADED	POWER		WEIGHT		
				SPEED	SPINDLE	W	hp	kg	lb.	
				rpm						
<b>VERTICAL SANDER</b>										
A	KL165B	615 170 011 0 +	615 399 364 0 or 615 399 365 0	6500	5/8"-11f.	1200	1.61	23	5.1	
<b>ANGLE SANDERS</b>										
B	KA9030A	615 170 098 0 +	615 396 126 0 or 615 396 125 0	3000	M14x2	900	1.21	1.6	3.5	
B	KA9030B	615 170 099 0 +	615 396 126 0 or 615 396 125 0	3000	5/8"-11f.	900	1.21	1.6	3.5	
B	KA9020A	615 170 096 0 +	615 396 126 0 or 615 396 125 0	2000	M14x2	900	1.21	1.6	3.5	
B	KA9020B	615 170 097 0 +	615 396 126 0 or 615 396 125 0	2000	5/8"-11f.	900	1.21	1.6	3.5	