

Accessories

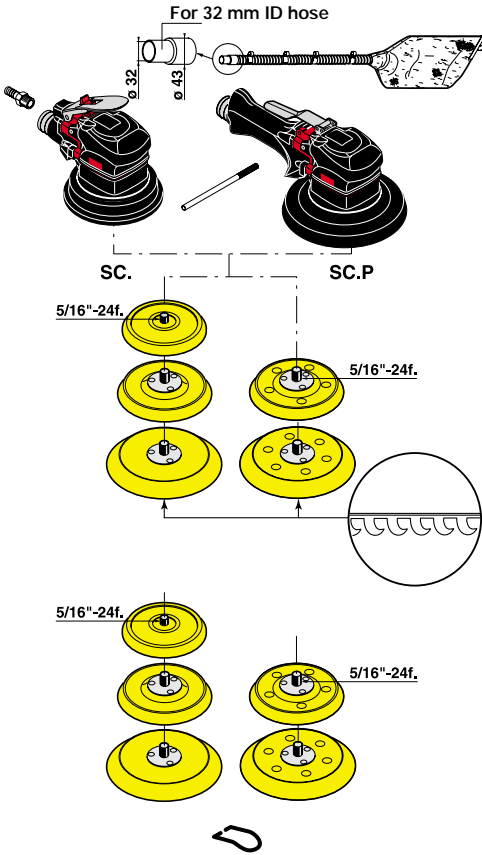
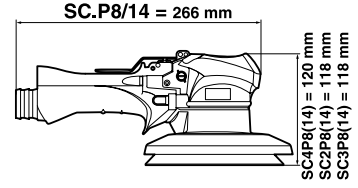
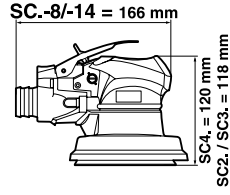
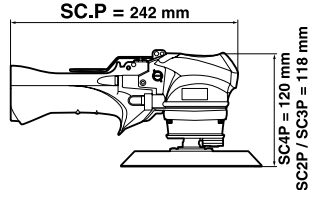
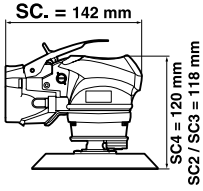

SC.. / SC..P

ACCESSORIES INCLUDED

	PART NO.
• 1/4" air hose nipple for 8 mm ID hose	615 704 019 0
• Clamping lever	615 595 202 0
• Complete dust extraction kit for version (-14)	615 399 471 0

Pads :	For velcro-backed abrasive	For drilled velcro-backed abrasive (-8) or (-14)
--------	----------------------------	--

• Pad ø 110 mm (4-3/8") - SC2(P) All versions	615 990 102 0	-
• Pad ø 127 mm (5") - SC3(P)	615 990 123 0	615 990 124 0
• Pad ø 150 mm (6") - SC4(P)	615 990 125 0	615 990 126 0

OPTIONAL ACCESSORIES

Pads :	For self-adhesive abrasive	For drilled self-adhesive abrasive (-8) or (-14)
--------	----------------------------	--

• Pad ø 110 mm (4-3/8") - SC2(P) All versions	615 990 101 0	-
• Pad ø 127 mm (5") - SC3(P)	615 990 111 0	615 990 110 0
• Pad ø 150 mm (6") - SC4(P)	615 990 119 0	615 990 118 0

	SC..P
• Suspension bail	615 570 532 0

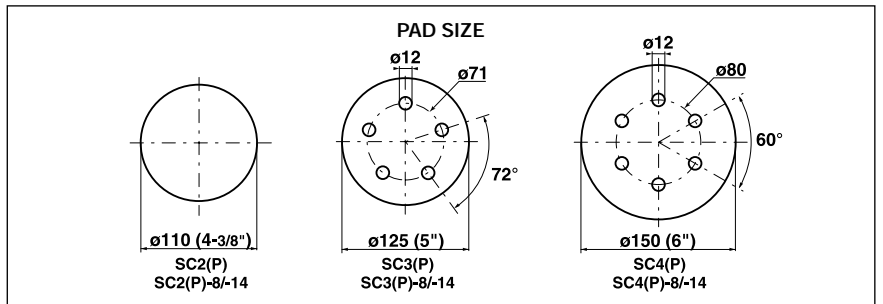

Lou Zampini & Associates

2 Douglas Pike, Rt. 7
Smithfield, RI 02917
1 800 353 4676
FAX 1 401 679 0165



Random orbital sanders for abrasive discs

ø 110 mm (4-3/8") - ø 127 mm (5")
 - ø 150 mm (6")
 375 Watts (0.5 hp) - 10 000 rpm



SC4



SC4P



SC4-8



SC4P8



SC4P14

Caution: comply with the speeds recommended by component and abrasive manufacturers

PAD		MODEL	PART	MODEL	PART	MODEL	PART	WEIGHT		AIR CONSUMPTION		AIR	HOSE
SIZE			NUMBER		NUMBER		NUMBER			AT MAX OUTPUT	INLET	INT.	
mm	inch							kg	lb.	l/s	cfm	inch	Ø
SANDERS WITH PALM GRIP													
		Suction-free		With dust extraction		Integral suction							
ø 110	4-3/8	SC2	615 1700800	SC2-8	615 1700920	SC2-14	615 1700860	1.1	2.42	11	23	1/4	8
ø 127	5	SC3	615 1700820	SC3-8	615 1700940	SC3-14	615 1700880	1.2	2.64	11	23	1/4	8
ø 150	6	SC4	615 1700810	SC4-8	615 1700930	SC4-14	615 1700870	1.3	2.86	11	23	1/4	8
SANDERS WITH HANDLE GRIP													
		Suction-free		With dust extraction		Integral suction							
ø 110	4-3/8	SC2P	615 1700770	SC2P8	615 1700890	SC2P14	615 1700830	1.2	2.64	11	23	1/4	8
ø 127	5	SC3P	615 1700790	SC3P8	615 1700910	SC3P14	615 1700850	1.3	2.86	11	23	1/4	8
ø 150	6	SC4P	615 1700780	SC4P8	615 1700900	SC4P14	615 1700840	1.4	3.08	11	23	1/4	8

Accessories

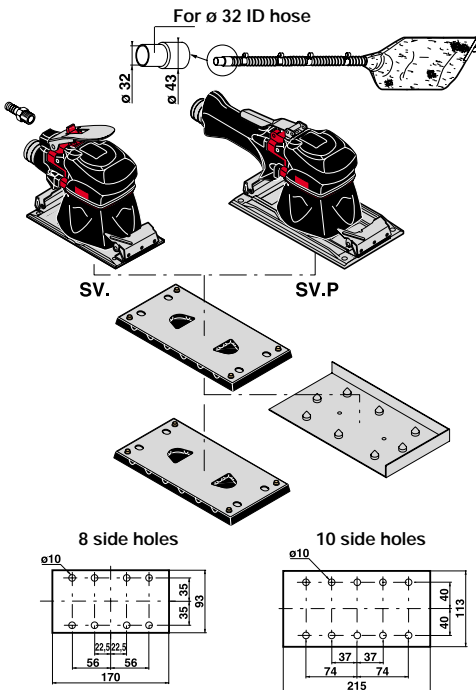
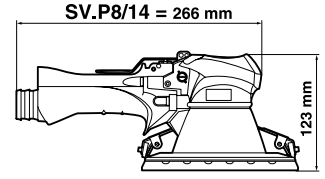
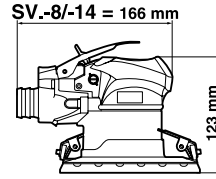
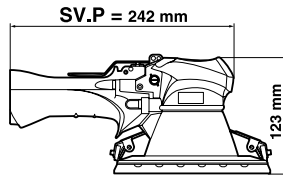
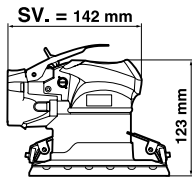

SV.. / SV..P

ACCESSORIES INCLUDED

- | | PART NO. |
|--|---------------|
| • 1/4" air hose nipple for 8 mm ID hose | 615 704 019 0 |
| • Complete dust extraction kit for version (-14) | 615 399 471 0 |

- | | Pad | Drilling plate for release (-8) or (-14) |
|----------------------------|---------------|--|
| • Pad 150 x 75 mm - SV2 | 615 350 017 0 | 615 990 093 0 |
| • Pad 170 x 93 mm - SV3(P) | 615 350 018 0 | 615 990 094 0 |
| • Pad 215 x 113 mm - SV4P | 615 350 019 0 | 615 990 095 0 |

OPTIONAL ACCESSORIES

- | | PART NO. |
|---|---------------|
| • Pad 170 x 93 mm - 8 side holes SV3(P) | 615 350 057 0 |
| • Pad 215 x 113 mm - 10 side holes SV4P | 615 350 058 0 |

- | | SV..P |
|-------------------|---------------|
| • Suspension bail | 615 570 532 0 |

SIZE OF SUPPLIED PADS

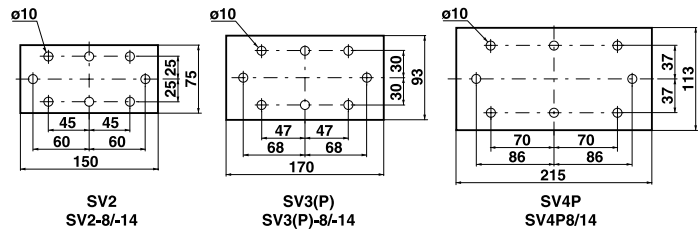

Orbital sanders for abrasive sheets

150 x 75 mm (6"x3")

170 x 93 mm (6-5/8"x3-5/8")

215 x 113 mm (8-1/2"x4-1/2")

375 Watts (0.5 hp) - 8 000 rpm



SV3



SV3P



SV3-8



SV3P8



SV3P14

Caution: comply with the speeds recommended by component and abrasive manufacturers

PAD SIZE		MODEL	PART NUMBER	MODEL	PART NUMBER	MODEL	PART NUMBER	WEIGHT		AIR CONSUMPTION AT MAX OUTPUT		AIR INLET THREAD	HOSE INT. Ø
mm	inch							kg	lb.	l/s	cfm	inch	mm

SANDERS WITH PALM GRIP

		Suction-free		With dust extraction		Integral suction							
150 x 75	6 x 3	SV2	615 1700650	SV2-8	615 1700730	SV2-14	615 1700690	1.5	3.30	11	23	1/4	8
170 x 93	6-5/8 x 3-5/8	SV3	615 1700660	SV3-8	615 1700740	SV3-14	615 1700700	1.7	3.74	11	23	1/4	8

SANDERS WITH HANDLE GRIP

		Suction-free		With dust extraction		Integral suction							
170 x 93	6-5/8 x 3-5/8	SV3P	615 1700670	SV3P8	615 1700750	SV3P14	615 1700710	1.8	3.96	11	23	1/4	8
215 x 113	8-1/2 x 4-1/2	SV4P	615 1700680	SV4P8	615 1700760	SV4P14	615 1700720	1.9	4.19	11	23	1/4	8

Accessories

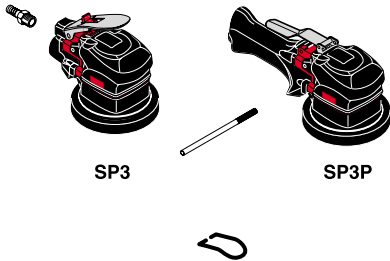
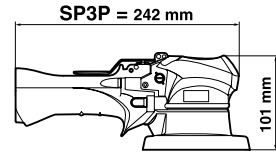
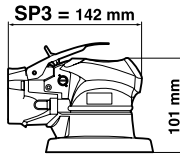

SP3 / SP3P

ACCESSORIES INCLUDED

- 1/4" air hose nipple for 8 mm ID hose
- Clamping lever

PART NO.

615 704 019 0

615 595 202 0

OPTIONAL ACCESSORIES

- Suspension ball

SP3P

615 570 532 0



Random orbital polishers with high offset \varnothing 127 mm (5")

375 Watts (0.5 hp) 10 000 rpm

Supplied with 5/16" F. tapped spindle only



SP3

Lou Zampini & Associates

2 Douglas Pike, Rt. 7
 Smithfield, RI 02917

1 800 353 4676

FAX 1 401 679 0165



SP3P

These polishers are balanced to be used with a velcro-backed pad \varnothing 127 mm (5"), thickness 16 mm (5/8"), weight 100 gr (0.22 lb), fitted with polishing foam, thickness 20 mm, weight 16 gr (0.03 lb).

Caution: comply with the speeds recommended by component and abrasive manufacturers

PAD SIZE		MODEL	PART NUMBER	WEIGHT		CONSUMPTION AT MAX OUTPUT		AIR INLET THREAD	HOSE INT. \varnothing
mm	inch			kg	lb	l/s	cfm	inch	mm

POLISHER WITH PALM GRIP

		Suction-free							
\varnothing 127	5	SP3	615 170 198 0	1.2	2.64	11	23	1/4	8

POLISHER WITH HANDLE GRIP

		Suction-free							
\varnothing 127	5	SP3P	615 170 197 0	1.3	2.86	11	23	1/4	8