

Accessories

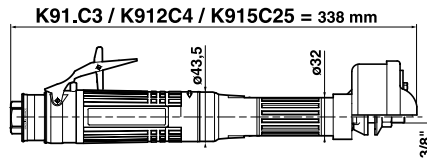
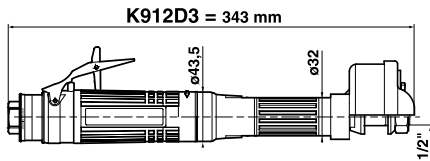

K9..

ACCESSORIES INCLUDED

ITEM	K912D3 ø 80 mm (3")	K915C25 ø 63 mm (2-1/2")
• Exhaust hose L = 1.5 m (60")	615 875 1130	615 875 1130
• Clamp	615 873 4150	615 873 4150
• 3/8" air hose nipple for 10 mm ID hose	615 704 0170	615 704 0170
1 Wheel guard	615 504 1510	615 504 1500
2 Rear flange	615 503 1270	615 503 1260
3 Front flange	615 502 0440	615 502 0430
4 Locknut	615 608 0450	615 608 0440
• Flat wrench, 17 mm (11/16")	-	615 801 0320
• Flat wrench, 14.3 mm (9/16")	-	615 801 0740
• Flat wrench, 19 mm (3/4")	615 801 0760	-

ITEM	K91.C3 ø 80 mm (3")	K912C4 ø 100 mm (4")
5 Wheel guard	615 504 1510	615 504 1520
6 Rear flange	615 503 1250	615 503 1310
7 Front flange	615 502 0130	615 502 0630
8 Locknut	615 608 0440	615 608 0440
• Flat wrench, 14.3 mm (9/16")	615 801 0740	615 801 0740
• Flat wrench, 19 mm (3/4")	615 801 0760	615 801 0760

OPTIONAL ACCESSORIES

ITEM	PART NO.
9 Spacer for collet-holder	615 666 1490
10 Series 200 collet-holder	615 523 0230
11 Series 200 collet nut	615 607 1440
12 Series 200 resilient collet	(see page 14)
13 Spacer for threaded cone wheel 3/8"	615 503 5160
• Rear flange supplied with tool 615 503 1250 or 615 503 1260	-
14 Complete silencer kit	615 396 1660
15 Inlet hose assembly L = 1.7 m (67") 3/8"M - 3/8"F ø 10 mm	615 870 2100
16 Reinforced cloth-lined exhaust hose L = 0.75 m (30")	615 875 1160

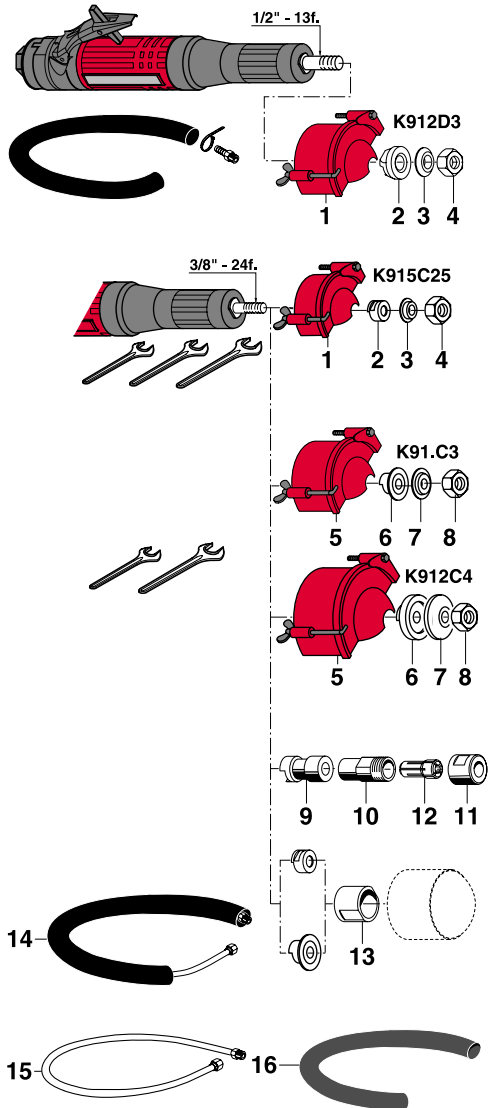

Grinders for cone wheels and type 1 wheels

Ø 63 mm (2-1/2") - Ø 80 mm (3") - Ø 100 mm (4")
900 Watts (1.21 hp) - 12 000 to 18 000 rpm



A



B



C



D

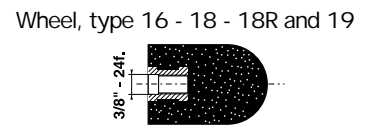
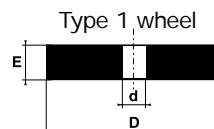

* Reinforced resinoid wheel

Caution: comply with the speeds recommended by component and abrasive manufacturers

PICTURE REF	MODEL	PART NUMBER	FREE SPEED	WHEEL MAX CAPACITY		THREADED SPINDLE	POWER		WEIGHT		AIR CONSUMPTION				AIR INLET THREAD	HOSE INT. Ø	
				D	Exd		W	hp	kg	lb.	AT FREE SPEED	AT MAX OUTPUT	l/s	cfm			l/s
A	K918C3	615 170 1180	18000	*80	x13x9.52	3x1/2x3/8	3/8-24f.	900	1.21	1.7	3.7	7	15	16	34	3/8	10
B	K915C25	615 170 1150	15000	63	x13x9.52	2-1/2x1/2x3/8	3/8-24f.	900	1.21	1.6	3.5	7	15	16	34	3/8	10
C	K912D3	615 170 1130	12000	80	x20x12.7	3x25/32x1/2	1/2-13f.	900	1.21	1.7	3.7	7	15	16	34	3/8	10
A	K915C3	615 170 1160	15000	*80	x13x9.52	3x1/2x3/8	3/8-24f.	900	1.21	1.7	3.7	7	15	16	34	3/8	10
A	K912C3	615 170 1110	12000	80	x13x9.52	3x1/2x3/8	3/8-24f.	900	1.21	1.7	3.7	7	15	16	34	3/8	10
D	K912C4	615 170 1120	12000	*100	x13x9.52	4x1/2x3/8	3/8-24f.	900	1.21	1.8	4.0	7	15	16	34	3/8	10

Accessories

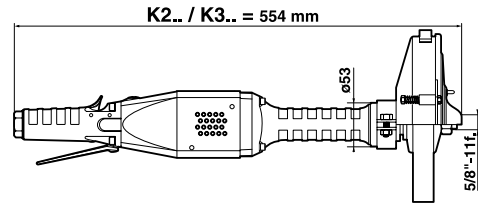
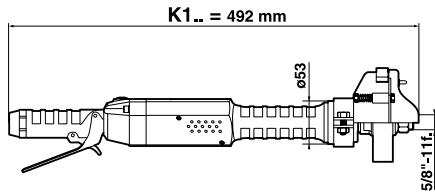

K190B3CW - ø 80 mm (3")

ACCESSORIES INCLUDED

ITEM	PART NO.
• 1/2" air hose nipple for 15 mm ID hose	615 704 014 0
1 Wheel guard	615 504 080 0
2 Rear flange	615 503 095 0
3 Woodruff key	615 630 019 0
• Flat wrench, 27 mm (1-1/16")	615 801 077 0

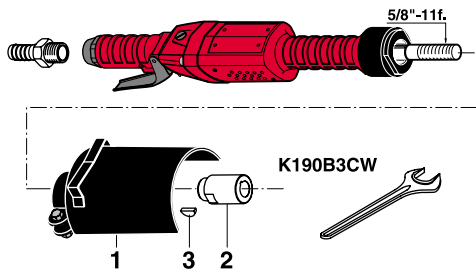

K190B4 / K160B6 / K145B6 / K260B6 / K360B6

ACCESSORIES INCLUDED

ITEM	K190B4 ø 100 mm (4")	K1..B6 K260B6 K360B6 ø 150 mm (6")
	• 1/2" air hose nipple for 15 mm ID hose	615 704 014 0
1 Wheel guard	615 504 154 0	615 504 079 0
2 Rear flange	615 503 094 0	615 503 028 0
3 Front flange	615 502 046 0	615 502 027 0
4 Nut	615 608 006 0	615 608 006 0
5 Woodruff key	615 630 019 0	615 630 019 0
• Flat wrench, 27 mm (1-1/16")	615 801 077 0	615 801 077 0

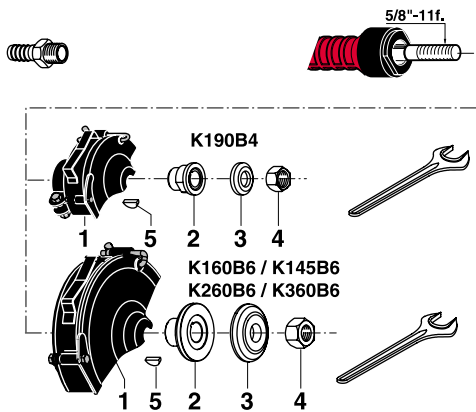

K245B8 / K345B8 - ø 200 mm (8")

ACCESSORIES INCLUDED

ITEM	K245B8 K345B8 ø 200 mm (8")
• 1/2" air hose nipple for 15 mm ID hose	615 704 014 0
1 Wheel guard	615 504 078 0
2 Rear flange	615 503 004 0
3 Front flange	615 502 007 0
4 Nut	615 608 006 0
5 Woodruff key	615 630 019 0
• Flat wrench, 27 mm (1-1/16")	615 801 077 0

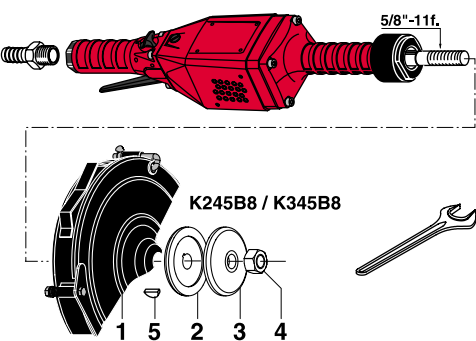

OPTIONAL ACCESSORIES

ITEM	K1..	K2.. / K3..
A Silencer kit	615 399 298 0	615 399 227 0
B Silencer kit	615 399 459 0	615 399 460 0

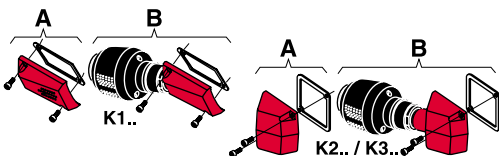

Grinders for cone wheels and type 1 wheels

∅ 80 mm (3") - ∅ 100 mm (4") - ∅ 150 mm (6")
- ∅ 200 mm (8")

1 000 to 2 700 Watts (1.34 to 3.62 hp) - 4 500 to 9 000 rpm

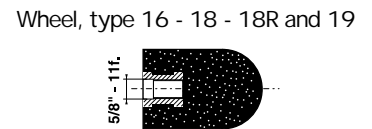
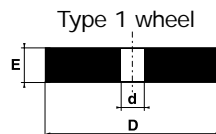
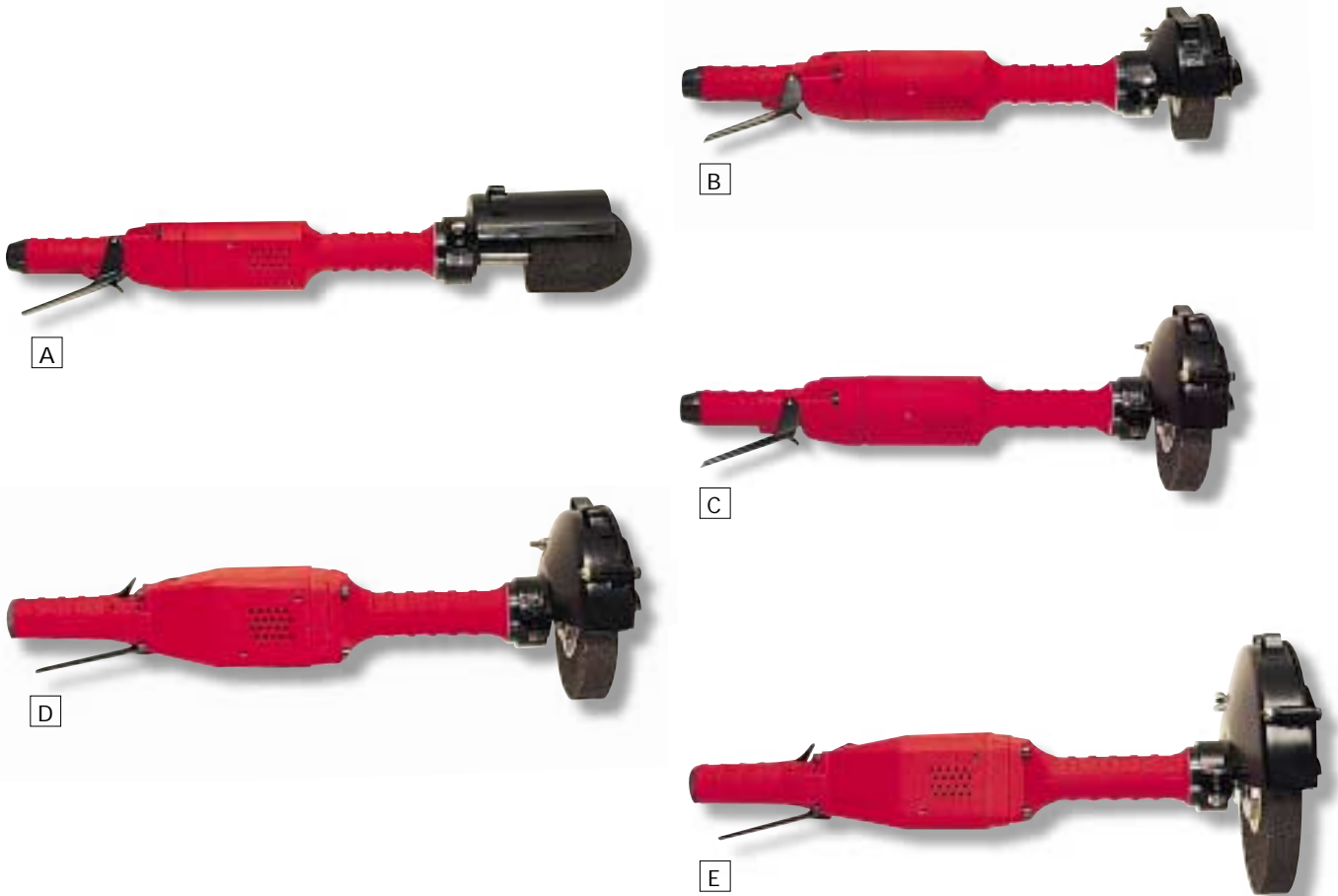

Caution: comply with the speeds recommended by component and abrasive manufacturers

PICTURE REF	MODEL	PART NUMBER	FREE SPEED rpm	WHEEL MAX CAPACITY DxExd		THREADED SPINDLE inch	POWER		WEIGHT		AIR CONSUMPTION				AIR INLET THREAD inch	HOSE INT. Ø mm
				mm	inch		W	hp	kg	lb.	l/s	cfm	l/s	cfm		
A	K190B3CW	615 170 005 0	9000	80	3	5/8-11f.	1 200	1.61	3.5	7.7	9	19	27	57	1/2	15
B	K190B4	615 170 004 0	9000	100x25x15.9	4x1x5/8	5/8-11f.	1 200	1.61	3.2	7.0	9	19	27	57	1/2	15
C	K160B6	615 170 003 0	6000	150x25x15.9	6x1x5/8	5/8-11f.	1 200	1.61	3.5	7.7	6	12	23	48	1/2	15
C	K145B6	615 170 002 0	4500	150x25x15.9	6x1x5/8	5/8-11f.	1 000	1.34	3.5	7.7	5	10	20	42	1/2	15
D	K260B6	615 170 008 0	6000	150x25x15.9	6x1x5/8	5/8-11f.	2 000	2.70	5.1	11.2	10	21	38	80	1/2	15
D	K360B6	615 170 010 0	6000	150x25x15.9	6x1x5/8	5/8-11f.	2 700	3.62	5.6	12.3	13	27	41	86	1/2	15
E	K245B8	615 170 006 0	4500	200x25x15.9	8x1x5/8	5/8-11f.	1 800	2.41	5.8	12.7	8	17	32	67	1/2	15
E	K345B8	615 170 009 0	4500	200x25x15.9	8x1x5/8	5/8-11f.	2 400	3.22	6.3	13.9	8	17	33	70	1/2	15

Accessories

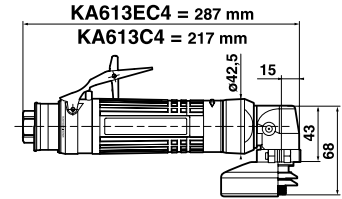
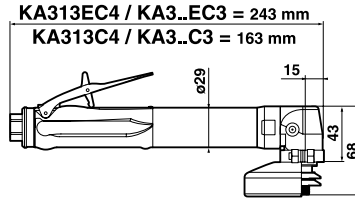

KA3..EC3 / KA3..C3 / KA313EC4 / KA313C4

ACCESSORIES INCLUDED

ITEM	KA3..EC3	KA313EC4
	KA3..C3	KA313C4
	ø 76 mm (3")	ø 100 mm (4")
• Exhaust hose L = 0.8m (31")	615 875 106 0	615 875 106 0
• 1/4" air hose nipple for 8 mm ID hose	615 704 019 0	615 704 019 0
1 Wheel guard	615 504 155 0	615 504 160 0
2 Flange	-	615 606 515 0
3 Flange	615 502 064 0	615 502 064 0
4 Flange	-	615 503 144 0
• Pin wrench, 20-3 mm	615 802 008 0	615 802 008 0
• Flat wrench, 11 mm (7/16")	615 801 003 0	615 801 003 0

OPTIONAL ACCESSORIES

ITEM	PART NO.	
5 Complete silencer kit	615 396 101 0	
6 Clipable silencer	615 396 124 0	
7 Grease gun (capacity 24 g.)	615 990 149 0	
• Lubricant for bevel gear (1 kg)	615 990 148 0	

KA613EC4 / KA613C4 - ø 100 mm (4")

ACCESSORIES INCLUDED

ITEM	KA613EC4	KA613C4
• Exhaust hose L = 1.5 m (60")	615 875 113 0	
• Clamp	615 873 415 0	
• 3/8" air hose nipple for 10 mm ID hose	615 704 017 0	
1 Wheel guard	615 504 160 0	
2 Flange	615 606 515 0	
3 Flange	615 502 064 0	
4 Flange	615 503 144 0	
• Pin wrench, 20-3 mm	615 802 008 0	
• Flat wrench, 11 mm (7/16")	615 801 003 0	

OPTIONAL ACCESSORIES

ITEM	PART NO.	
5 Complete silencer kit	615 396 166 0	
6 Inlet hose assembly L = 1.7 m (67") 3/8"M - 3/8"F ø 10 mm	615 870 210 0	
7 Reinforced cloth-lined exhaust hose L = 0.75 m (30")	615 875 116 0	
8 Grease gun (capacity 24 g.)	615 990 149 0	
• Lubricant for bevel gear (1 kg)	615 990 148 0	

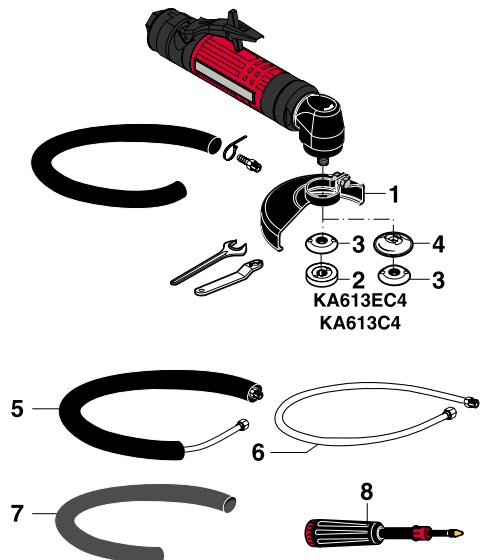
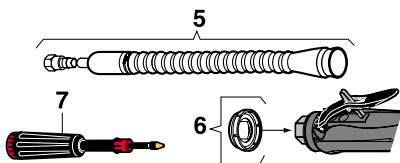
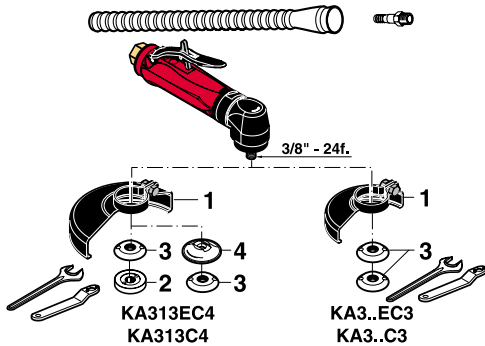

Grinders for depressed centre wheels and cut-off wheels

∅ 76 mm (3") - ∅ 100 mm (4")

375 - 600 Watts (0.5 - 0.8 hp) - 13 000 to 20 000 rpm

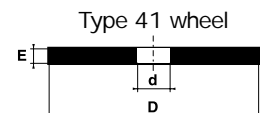
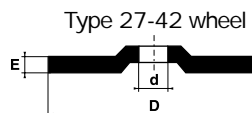

Caution: comply with the speeds recommended by component and abrasive manufacturers

PICTURE REF	MODEL	PART NUMBER	FREE SPEED	WHEEL MAX CAPACITY		THREADED SPINDLE	POWER	WEIGHT		AIR CONSUMPTION				AIR INLET THREAD	HOSE INT. Ø	
				mm	inch			W	hp	kg	lb.	l/s	cfm			l/s
A	KA320EC3	615 170 046 0	20000	76 x7x9.52	3x1/4x3/8	3/8-24f.	375	0.5	0.81	1.78	6.5	13.5	10.0	21	1/4	8
A	KA318EC3	615 170 045 0	18000	76 x7x9.52	3x1/4x3/8	3/8-24f.	375	0.5	0.81	1.78	4.5	9.5	9.5	20	1/4	8
B	KA313EC4	615 170 050 0	13000	100 x7x9.52&15.9	4x1/4x3/8&5/8	3/8-24f.	375	0.5	0.83	1.83	3.0	6.5	9.0	19	1/4	8
C	KA320C3	615 170 042 0	20000	76 x7x9.52	3x1/4x3/8	3/8-24f.	375	0.5	0.64	1.41	6.5	13.5	10.0	21	1/4	8
C	KA318C3	615 170 041 0	18000	76 x7x9.52	3x1/4x3/8	3/8-24f.	375	0.5	0.64	1.41	4.5	9.5	9.5	20	1/4	8
D	KA313C4	615 170 049 0	13000	100 x7x9.52&15.9	4x1/4x3/8&5/8	3/8-24f.	375	0.5	0.66	1.45	3.0	6.5	9.0	19	1/4	8
E	KA613EC4	615 170 138 0	13000	100 x7x9.52&15.9	4x1/4x3/8&5/8	3/8-24f.	600	0.8	1.50	3.30	10.0	21.0	15.0	32	3/8	10
F	KA613C4	615 170 137 0	13000	100 x7x9.52&15.9	4x1/4x3/8&5/8	3/8-24f.	600	0.8	1.20	2.60	10.0	21.0	15.0	32	3/8	10



Accessories

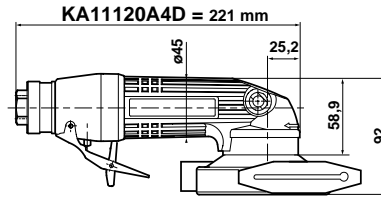
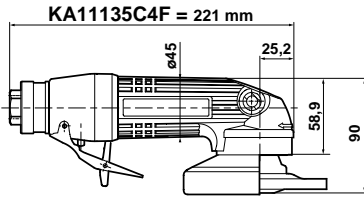

KA11135C4F / KA11120A4D - ø 100 mm (4")

ACCESSORIES INCLUDED

ITEM	KA11135C4F 3/8" - 24f.	KA11120A4D M14x2
• Exhaust hose L = 1.5 m (60")	615 875 1130	615 875 1130
• Clamp	615 873 415 0	615 873 415 0
• 3/8" air hose nipple for 13 mm ID hose	615 704 027 0	615 704 027 0
• Side handle	-	615 576 038 0
1 Wheel guard	615 504 143 0	615 396 076 0
2 Rear flange	-	615 503 134 0
3 Front flange	-	615 502 066 0
4 Flange	615 606 515 0	
5 Spacer	-	615 643 074 0
• Pin wrench, 35 mm (1-3/8")	-	615 802 010 0
• Pin wrench, 20-3 mm	615 802 008 0	
• Flat wrench, 17 mm (11/16")	615 801 032 0	
• Hex. key 8 mm (5/16")		615 802 061 0

OPTIONAL ACCESSORIES

ITEM	PART NO.
6 Complete silencer kit	615 396 166 0
7 Inlet hose assembly L = 1.7 m (67") 3/8"M - 3/8"F ø13 mm	615 804 064 0
8 Reinforced cloth-lined exhaust hose L = 0.75 m (30")	615 875 116 0
9 Vibration-damping side handle	615 576 066 0
10 Thermal insulating sleeve	615 570 412 0
11 Grease gun (capacity 24 g.)	615 990 149 0
• Lubricant for bevel gear (1 kg)	615 990 148 0

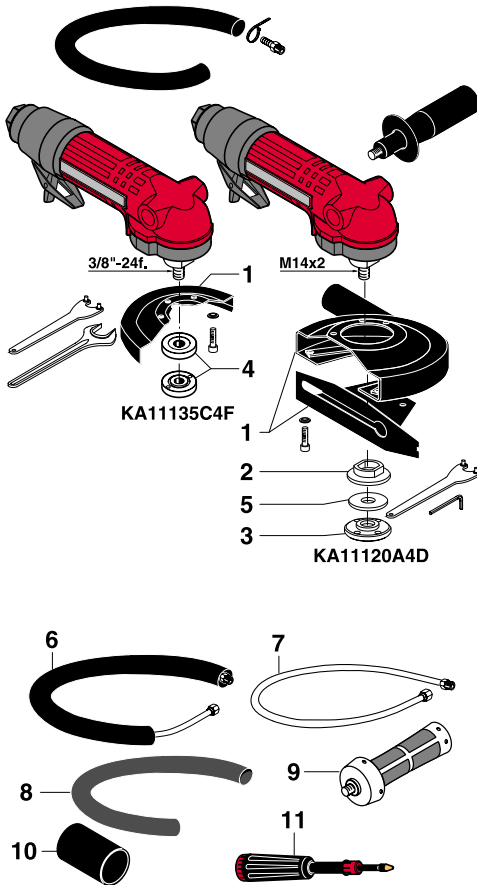

Grinders for depressed centre wheels, cut-off wheels and diamond discs Ø 100 mm (4")

1 100 Watts (1.5 hp) - 12 000 - 13 500 rpm



A

Adjustable lever



B

Adjustable lever

Supplied with dust extraction casing
for diamond disc Ø 100 mm (4").
Vacuum hose, ID 25 mm (1")

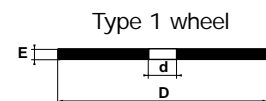
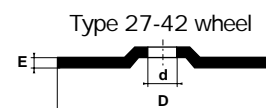

Caution: comply with the speeds recommended by component and abrasive manufacturers

* Diamond disc

PICTURE REF	MODEL	PART NUMBER	FREE SPEED	WHEEL MAX CAPACITY		THREADED SPINDLE	POWER		WEIGHT		AIR CONSUMPTION				AIR INLET THREAD	HOSE INT. Ø	
				DxExd			W	hp	kg	lb.	At Free Speed	At Max Output	At Free Speed	At Max Output			
			rpm	mm	inch							l/s	cfm	l/s	cfm	inch	mm
A	KA11135C4F	615 170 057 0	13500	100x6.4x16	4x1/4x5/8	3/8"-24f.	1100	1.5	1.6	3.5	10	21	20	42	3/8	13	
B	KA11120A4D*	615 170 059 0	12000	100x3.2x22.2	4x1/8x7/8	M14x2	1100	1.5	2.0	4.4	10	21	20	42	3/8	13	

Abrasive accessories

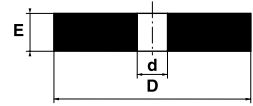

FLAT WHEELS, TYPE 01

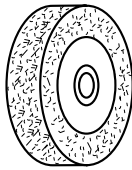

SPEED MAX rpm	D mm	E mm	d mm	PART NO.
15 000	63	12.7	9.5	615 840 060 0
12 000	80	20	12.7	615 840 081 0
9 500	100	25	15.8	615 840 100 0
6 400	150	25	15.8	615 840 150 0

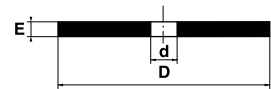

FLAT WHEELS, TYPE 41 (1R)

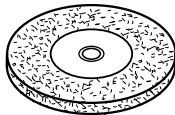

SPEED MAX rpm	D mm	E mm	d mm	PART NO.
20 000	76	1.8	9.5	615 842 081 0
20 000	76	6.4	9.5	615 842 085 0
10 000	150	25.0	25.0	615 842 150 0



CONE WHEELS, TYPE 18 R

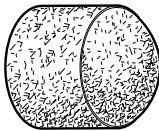

SPEED MAX rpm	D mm	d inch	PART NO.
15 000	63	5/8-11f.	615 840 063 0
12 000	76	5/8-11f.	615 840 083 0

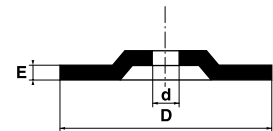

DEPRESSED CENTRE WHEELS, TYPE 27 and 42*

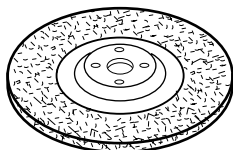

SPEED MAX rpm	D mm	E mm	d mm	PART NO.
20 000	76	25	10.0	615 841 006 0*
20 000	76	7.0	10.0	615 841 003 0
15 000	100	3.2	15.8	615 841 103 0
15 000	100	6.4	15.8	615 841 106 0
12 000	127	1.8	22.2	915 842 127 0
12 000	127	3.2	22.2	615 841 123 0
12 000	127	4.8	22.2	615 841 125 0
12 000	127	6.4	22.2	615 841 126 0

