

Environment

OPERATOR INTERFACE

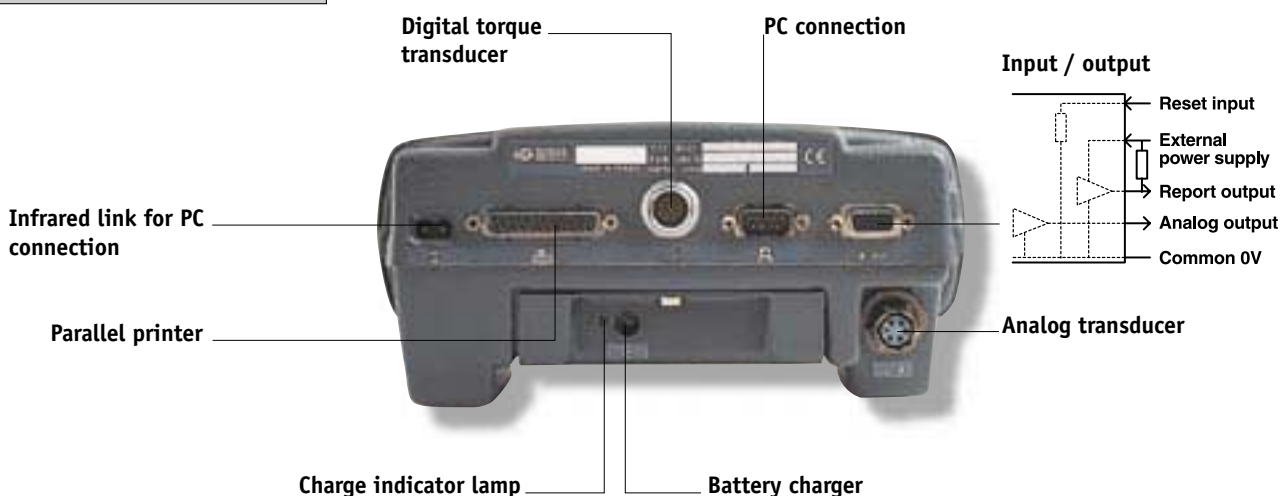

CONNECTIONS



How to order

	PART NUMBER
DELTA4000 unit	615 935 035 0

ACCESSORIES INCLUDED

	PART NUMBER
Universal charger	
Mains power cord (to be specified on order):	
EUROPE (Except G.B.)	615 917 201 0
G.B.	615 917 202 0
U.S.A.	615 917 203 0

OPTIONAL ACCESSORIES

	PART NUMBER
Extra battery block	615 935 036 0
SDOPC software (please consult our department)	615 927 520 0
Analog torque cable, 2m long	615 917 251 0
Analog torque cable, 5m long	615 917 252 0
Spirally wound analog torque cable (stretched: 2m)	615 917 253 0
Unit/PC connection cable, RS232C type	615 917 047 0
Parallel printer cable	615 917 057 0

Delta 4000

DESIGNED FOR YOUR CHECKING CAMPAIGNS



DELTA4000 is an easy-to-use versatile system which allows you to measure torque values proceeding from analog or digital transducers.

The parameters and features of all the transducers in the range are stored in DELTA4000 and are taken into account by simple selection of the transducer:

- Rotary transducers, CMD4000 type
- Static transducers, ST4000 type
- Handle wrenches, CD or CF type.

The transducers of EM type electric tightening tools (digital torque transducer) are AUTOMATICALLY recognised.

Its **memory** contains up to 5,000 results. **Lightweight and self-contained**, it can operate during 8 hours without second charge or change of batteries. An easily extractible extra battery block allows you to double this operating time. The data autosave allows you to perform this operation without loss of results.

As a simple versatile system, DELTA4000 offers the possibility of connecting all types of **printers** in parallel. Two types of **PC link**, infrared and serial RS232C are available.

CHECKING CAMPAIGNS

• Checking operation:

Sequence of checking operations throughout the assembly line to make sure that the tightening tools are still tightening to the specified torque.

Each checking operation includes all the parameters required for its performance (type of transducer to be used – number of required readings – specified torque - tolerances – etc.).

• Manual sequencing:

As the checks progress, the operator calls the checking operation corresponding to the station in front of him in the order chosen by him/her.

• Automatic sequencing:

The selection of the various operations to be carried out is automatically in increasing order, which saves the operator the handling operations to select them.

• Number of operations:

You can program up to 1,000 operations. Each operation can include 4 to 5,000 reading results according to the number of operations stored.

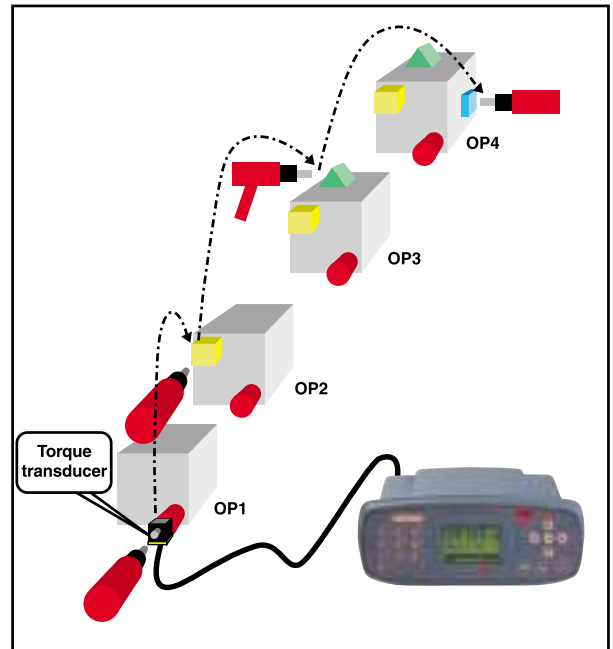

Successive check of the torque applied by the tightening tools

APPLICATIONS



Calibration of pneumatic screwdrivers



Calibration of torque wrenches



Reading the torque applied by pneumatic oil pulse wrenches.



Calibration of controlled electric nutrunners.

Delta 4000

INTEGRATED STATISTICAL CALCULATIONS

- CAM, CP and CPK calculation and measurement of mean range on torque values in accordance with ISO and CNOMO standards.
- Data screening (date or value interval).
- Tolerance interval selection.
- "Population homogeneity" test.
- "Normal distribution" test.

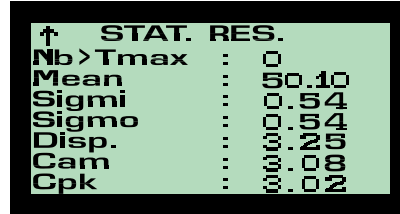

↑ STAT. RES.	
Nb > Tmax	: 0
Mean	: 50.10
Sigma	: 0.54
Sigma	: 0.54
Disp.	: 0.29
Cam	: 0.08
Cpk	: 0.02

The results of the measurements can be exported to other software programmes:

- Statistical calculation software in order to:
 - Store the results and perform statistical calculations in the same way as with the measuring unit.
 - Display histograms or control charts.
- Excel type software or any other data base in order to:
 - Save and process the results.
 - Display the reading curve.

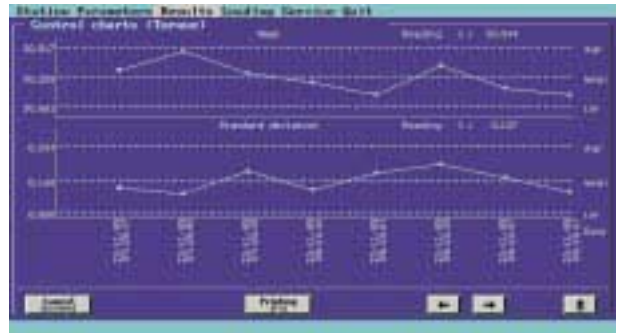

2 OPERATING MODES

Acquisition Mode:

In this mode, DELTA4000 allows the operator to acquire and store torque values:

- Either automatically, after each tightening operation.
- Or manually, by pressing the VAL key.

In manual mode, 2 types of reading are available:

- Peak: displays and stores the maximum torque read.
- Track: the values displayed follow the evolution of the torque in a continuous process.

Examples of application in track mode:

- Hand torque measuring wrenches (CF, CD).
- Reading the tension in a joint with a force meter.
- Calibration of assembling machines in "static mode".

In this mode, the values are not stored.

Programming Mode:

With its intuitive ergonomic design, DELTA4000 can be programmed by using the 5 browsing keys and the multifunction alphanumeric keys of the keyboard.

It is supplied with a standard programming configuration which meets most common applications. However, several programming menus are available to help personalize the programming very easily. It can be re-configured in no time.

The unit is multilingual: French, English, German, Spanish ..., other languages on request.

FIELDS OF APPLICATION



Car industry



Aeronautics



TGV (high speed train)



Electronics

Features

POWER REQUIREMENTS

POWER SUPPLY	Extractible and rechargeable battery of 6 x 1.2 V (7.2V) NiMH elements inside or outside the unit.
BATTERY LIFE	8 hours – 1,000 Discharging / Recharging cycles– Programmable automatic stop.
BATTERY CONTROL	Weak battery indication – Power miser – Charge level test – Global data backup during battery change.
CHARGER	Multi-voltage 115/230 Volts with multi-standard mains power cord.

TORQUE

2 TRANSDUCER INPUT CONNECTIONS	Connection of strain gauge transducers, CMD / ST / CD / CF /TD type or others. Digital serial link for connecting and reading the torque of fixed electric tightening tools.				
TRANSDUCER RANGE	4001	4005	4010	4050	4100
	1-15 Nm	10-70 Nm	10-150 Nm	100-700 Nm	100-1500 Nm
TORQUE RESOLUTION	0.001 Nm	0.01 Nm	0.01 Nm	0.1 Nm	0.1 Nm
ABSOLUTE MAXIMUM UNCERTAINTY (unit alone)	± 0.006 Nm	± 0.06 Nm	± 0.06 Nm	± 0.6 Nm	± 0.6 Nm
RANGE CHANGEOVER SENSITIVITY	Automatic, according to the transducer selected. Automatic selection according to the transducer selected. Automatic reading in the case of fixed electric power tools 0.5 to 2.5 mV/V for any other transducer (load to be specified).				
TRANSDUCER LOAD	Automatic selection according to the transducer selected. Automatic reading in the case of fixed electric power tools. Torque: from 1 to 10 000 Nm for any other transducer. Force: from 1 to 50 000 daN				
UNITS	Nm – Ft.lb – In.lb – N – daN – kN				

SETTING

JOINT	Selection of the type of joint and application: Hard - Standard - Soft – Breakaway Special mode for reading the torque of pneumatic oil pulse wrenches.
ZERO POINT ADJUSTMENT	Automatic zero correction and digital storage on each reset of the display.
DISPLAY RESET	Manual - External - Automatic (programmable).
OPERATING MODE	Acquisition mode. Programming mode.

COMMUNICATION

LEDs	Tightening reports: Torque OK - Mini torque – Maxi torque.
INPUT	Resetting the reading and storing the result (0 – 24V ; input impedance 560k Ω). Resetting the reading without storing the result (0 – 24V ; input impedance 560k Ω).
OUTPUT	3 tightening reports: Accept – Mini – Maxi (External power supply 5 to 30V ; Max. current 100mA). Torque reached for action on external device (External power supply 5 to 30V ; Max. current 100mA). Analog torque output (0-10V ; max. load 10k Ω)
MEMORY	Up to 5,000 results (for 1 single operation programmed) including Torque, Date and Time. 1 curve that can be programmed and displayed on PC. Up to 1,000 checking operations (4 results)
STATISTICS	ISO and CNOMO: CAM, CPK, Mean, Standard deviation
PRINTER	Connected to SubD 25 point parallel port with printing: - either in order of occurrence (reading after reading, automatically). - or in increments of N readings starting from a given date.
P.C. DOWNLOADING	Via serial link RS232 on SubD 9 points. Via infrared link.

MISCELLANEOUS

WEIGHT	875 g
OVERALL SIZE	Depth 170 mm - Width 230 mm - Height 100 mm
TEMPERATURES	Storage : from –10°C to +60°C - Operation: from 0°C to +50°C

Features

POWER REQUIREMENTS

POWER SUPPLY	Extractible and rechargeable battery of 6 (1.2 V) NiMH elements (i.e. 7.2 V) inside or outside the unit.
BATTERY LIFE	8 hours – 1,000 Discharging / Recharging cycles– Automatic stop when not used during the selected time.
BATTERY CONTROL	Weak battery indication – Power miser – Charge level test – Global backup of context during battery change.
CHARGER	Multi-voltage 115/230 Volts with multi-standard mains power cord.

TORQUE

2 TRANSDUCER INPUT CONNECTIONS	Connection of strain gauge transducers of CMD / ST / CD / CF /TD type or others. Digital serial link for connecting and reading the torque of fixed electric tightening tools.									
TRANSDUCER RANGE	4001		4005		4010		4050		4100	
	1-15 Nm	0.7-11 ft-lb	10-70 Nm	7.4-52 ft-lb	10-150 Nm	7.4-111 ft-lb	100-700 Nm	74-517 ft-lb	100-1500 Nm	74-1106 ft-lb
TORQUE RESOLUTION	0.001 Nm	0.0007 ft-lb	0.01 Nm	0.007 ft-lb	0.01 Nm	0.007 ft-lb	0.1 Nm	0.07 ft-lb	0.1 Nm	0.07 ft-lb
MAXIMUM RESOLUTION (unit alone)	± 0.006 Nm	± 0.004 ft-lb	± 0.06 Nm	± 0.04 ft-lb	± 0.06 Nm	± 0.04 ft-lb	± 0.6 Nm	± 0.44 ft-lb	± 0.6 Nm	± 0.44 ft-lb
RANGE SWITCHING	Automatic, according to the transducer selected.									
SENSITIVITY	Automatic selection according to the transducer selected. Automatic reading in case of fixed electric power tools. 0.5 to 2.5 mV/V for any other transducer (load to be specified).									
TRANSDUCER LOAD	Automatic selection according to the transducer selected. Automatic reading in case of fixed electric power tools. Torque: from 1 to 10 000 Nm for any other transducer. Force: from 1 to 50 000 daN.									
UNITS	Nm – Ft.lb – In.lb – N – daN - kN									

SETTING

JOINT	Selection of the type of joint and application: Hard - Standard - Soft Special mode for reading the torque of pneumatic oil pulse wrenches.
ZERO POINT ADJUSTMENT	Automatic zero correction independant from clearing of the display.
CLEARING THE DISPLAY	Manual - External - Automatic (programmable).
OPERATING MODE	Acquisition mode Programming mode

COMMUNICATION

MEMORY	Up to 1 000 results including Torque, Date and Time
PRINTER	Connected on SubD 25 point parallel port with printing: - either in order of occurrence (reading after reading, automatically) - or in increments of N readings starting from a given date
PC DOWNLOADING	Via serial link RS232 on SubD 9 points Via infrared link

MISCELLANEOUS

WEIGHT	875 g. / 1.93 lbs
OVERALL DIMENSIONS	Depth: 170 mm - Width: 230 mm – Height: 100 mm
TEMPERATURES	Storage: from -10°C to +70°C / 14°F to 140°F Operation: from 0°C to +50°C / 32°F to 122°F

Environment

OPERATOR INTERFACE



CONNECTIONS

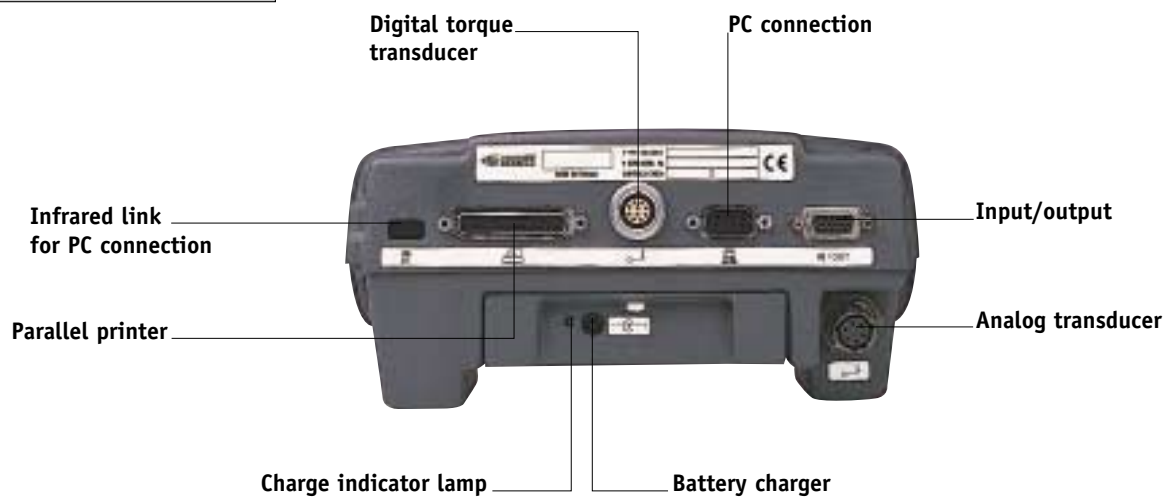

PART No

	PART No
SIGMA2001 unit	615 935 037 0

ACCESSORIES INCLUDED

	PART No
Universel charger	615 922 948 0
Multilanguages documentation	615 993 800 0

START-UP KIT to be ordered with the controller

Including : Plug and cable

PLUG	PART No
A	615 917 201 0
C	615 917 202 0
D	615 917 205 0
B	615 917 203 0
E	615 917 204 0

OPTIONAL ACCESSORIES

	PART No
Extra battery block	615 935 036 0
DELTA PC software*	615 927 520 0
Analog torque cable, 2 m long	615 917 251 0
Analog torque cable, 5 m long	615 917 252 0
Spirally wound analog torque cable (stretched: 2 m)	615 917 253 0
Unit/PC connection cable, type RS232C	615 917 047 0
Parallel printer cable	615 917 057 0

*available in 2001

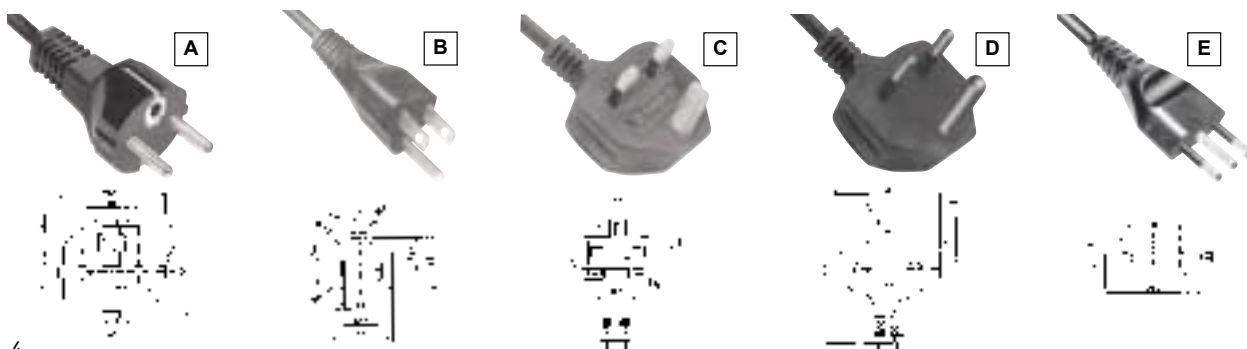

Sigma 2001

1 UNIT, 1 TRANSDUCER, 1 CABLE

SIGMA2001 is an easy-to-use system which allows you to measure torque values proceeding from analog or digital transducers.

The parameters and features of all the transducers of the range are stored in SIGMA2001 and are taken into account by simple selection of the transducer:

- Dynamic transducers of CMD4000 type
- Static transducers of ST4000 type
- Torque screwdrivers TD2001
- Hand wrenches of CD or CF type

The transducers of EM type electric tightening tools (digital torque transducer) are AUTOMATICALLY recognised.

Its **memory** contains up to 1,000 results. **Lightweight and self-contained**, it can operate during 8 hours with-

out second charge or change of batteries. An easily extractible extra battery block allows you to double this operating time.

A simple, although complete system, SIGMA2001 offers the possibility of connecting all types of **printers** in parallel. Two types of **PC link**, infrared and serial RS232C

The **associated "DELTA PC" PC software** allows you to:

- Download, display and store the results recorded in the unit
- Transfer these data to an Excel type file or other data base
- Perform statistical calculations in accordance with ISO or CNOMO standards

APPLICATIONS



Calibration of pneumatic screwdrivers



Sampling check of the torque applied in a joint



Checking the torque on multi-spindle machine



Calibration of controlled electric screwdrivers



Calibration of torque wrenches

Sigma 2001

THE SIMPLEST OF ALL MEASURING UNITS

MEASURING SCREEN

Value of measured torque on 5 digits + decimal point.
Display of the mean and range of the last 5 measurements.
Selection of the operating mode: peak/track.
Selection of the reset mode: manual/automatic/external.

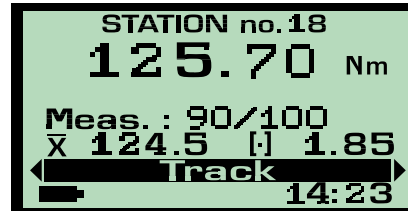

2 OPERATING MODES

Acquisition Mode:

In this mode, SIGMA2001 allows the operator to acquire and store torque values in:

- Automatic mode: after each tightening operation
- Manual mode: by pressing the "VAL" key.

In manual mode: 2 types of reading can be used:

- Peak: displays and stores the maximum torque read
- Track: the values displayed follow the evolution of the torque in a continuous process.

Examples of applications:

- Hand torque measuring wrenches (CF, CD).
- Reading the tension in a joint with a load transducer.
- Calibration of assembling machines in "static mode"

In this mode, the values are not stored.

Programming Mode:

With its proven ergonomic programming design, SIGMA2001 can be programmed by using the 5 browsing keys of the keyboard.

It is supplied with a standard programming configuration which meets most common applications. However, several programming menus are available and are quite easy to modify.

The unit is multilingual: French, English, German, Spanish, other languages on request.

FIELDS OF APPLICATION



Car industry



Aeronautics



TGV (high speed train)



Electronics

Torque wrenches and screwdrivers

SETTING OR CHECKING THE TORQUE APPLIED IN A JOINT

The **CD – CF** and **TD** type torque transducers are used to check and correct torque on already tightened joints by breakaway measurement on re-tightening.

They also allow you to perform the tightening operation itself while monitoring the progress of the torque value. The active component is a bending test bar to which the strain gauges are glued.

They can be connected to any measuring unit of the **GEORGES RENAULT** range by means of a plug located at the end of the arm or the cord.

TORSION STATIC TORQUE WRENCHES - CD Series

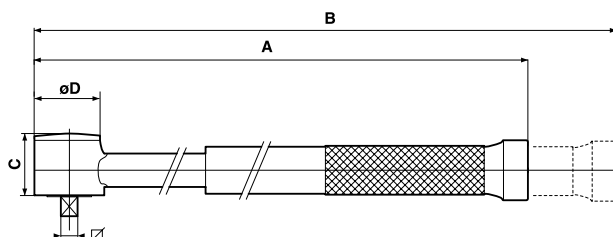

FLECTION STATIC TORQUE WRENCHES - CF Series (patented)

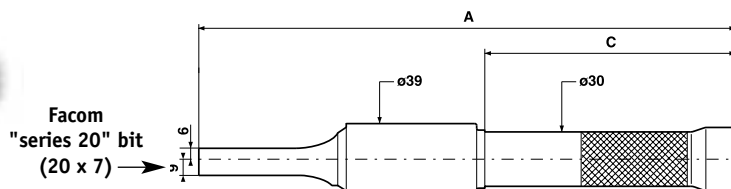

Essentially designed to be fitted with open end wrenches for any torque check on components such as brake or injection pipes, etc. where it is impossible to use socket type bits, these wrenches include flexion test pieces. Due to their original design, measurement is independent both of the point of application of the force and hand position. To allow this, it is essential that the nut axis be at a fixed distance from the mechanical bit stop, a condition met by Facom "series 20" bits.

TD2001 TORQUE SCREWDRIVER

The screwdriver is fitted with a spirally wound cord (extended length 1.5 m) for connection to a torque measuring unit.

It is supplied in a case specially designed for screwdriver bits.

For any tightening accessory, refer to the "Tightening Accessories" catalogue.

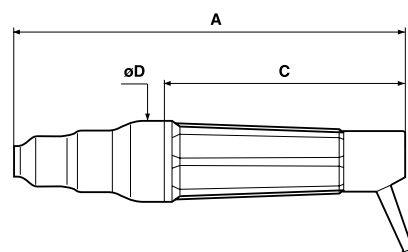

Uncertainty for any type of transducer: \pm (0.3 % of the measurement + Linearity)

PART NUMBER	MODEL	TORQUE RANGE Nm	SENSITIVITY		LINEARITY UNCERTAINTY Nm	SQUARE DRIVE		DIMENSIONS (mm)				WEIGHT kg
			mV/V	For Nm		Inch	mm	A	B WITH TELESCOPIC HANDLE	C	D	
615 165 146 0	CD4001	1 - 15	1.475	10	0.02	3/8	9.52	280	W/0	35	35	0.6
615 165 147 0	CD4005	5 - 70	1.475	100	0.10	3/8	9.52	335	W/0	35	35	0.7
615 165 148 0	CD4010	10 - 150	1.475	100	0.20	1/2	12.70	524	W/0	35	35	1.3
615 165 149 0	CD4050	50 - 700	1.475	1000	2.00	3/4	19.05	775	1140	64	80	6.0
615 165 150 0	CD4100	100 - 1500	1.475	1000	2.00	1	25.40	1025	1640	64	80	8.0
615 165 151 0	CF2005	5 - 70	1.475	100	0.40		20 x 7	295	W/0	138	/	0.9
615 165 152 0	CF2010	10 - 150	1.475	100	0.40		20 x 7	350	W/0	192	/	1.0
615 165 153 0	TD2001	1 - 15	1.475	10	0.02	HEX 1/4	6.35	205	W/0	124	40	0.4

Rotary transducers

MONITOR WHILE SETTING THE TORQUE APPLIED IN A JOINT

These rotary transducers can be inserted between the nutrunner and the fastener, with or without our range of transducer-holders.

The test piece is rotated by means of two oil-proof bearings and a rotary collecting system / anti-bounce multipoint contact brushes for electrical connections.



Strain gauges

CMD4000 - TORQUE Series (for torque monitoring, it can be used with any type of **GEORGES RENAULT** measuring unit)

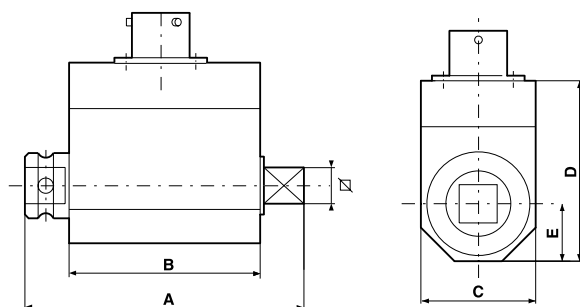

CCMD5000 - TORQUE & ANGLE Series (can be used with the TORQUE & ANGLE measuring unit COSMOS5000)

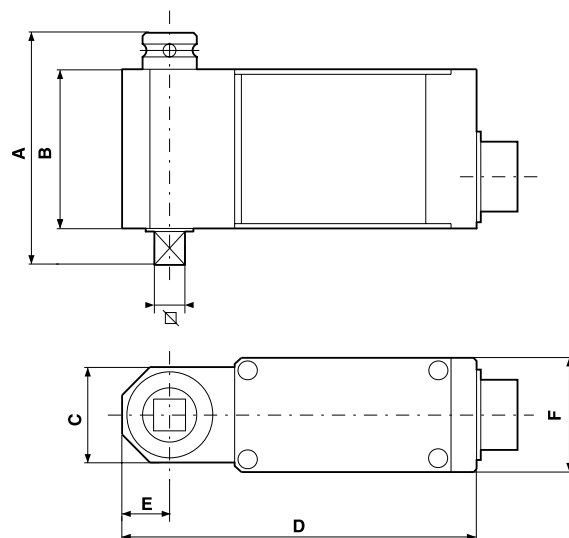

These transducers allow you to measure two parameters:

- Torque measurement by means of strain gauges (left and right rotations).
- Angle measurement by means of an optical encoder (count up and count down).

They are indispensable to check and test precision or safety joints, for which tightening strategies using the rotation angle of the fastener are implemented.

Uncertainty for any type of transducer: $\pm (0.3\% \text{ of the measurement} + \text{Linearity})$

PART NUMBER	MODEL	TORQUE RANGE Nm	SENSITIVITY		UNCERTAINTY		SQUARE DRIVE		DIMENSIONS (mm)						MAXI SPEED rpm	WEIGHT kg
			mV/V	For Nm	LINEARITY Nm	ANGLE degree	Inch	mm	A	B	C	D	E	F		
615 165 131 0	CMD4001	1 - 15	1.475	10	0.02	± 0.5	3/8	9.52	73	50.0	30	51	15.0	/	2000	0.2
615 165 132 0	CMD4005	5 - 70	1.475	100	0.10	± 0.5	3/8	9.52	73	50.0	30	51	15.0	/	2000	0.2
615 165 133 0	CMD4010	10 - 150	1.475	100	0.20	± 0.5	1/2	12.70	73	47.5	41	57	21.0	/	2000	0.4
615 165 134 0	CMD4050	50 - 700	1.475	1000	1.00	± 0.5	3/4	19.05	100	62.0	57	72	27.5	/	1000	0.9
615 165 135 0	CMD4100	100 -1500	1.475	1000	2.00	± 0.5	1	25.40	143	92.0	90	101	50.0	/	1000	2.4
615 165 136 0	CMD5001	1 - 15	1.475	10	0.02	± 0.5	3/8	9.52	73	50.0	30	111	15.0	36	2000	0.4
615 165 137 0	CMD5005	5 - 70	1.475	100	0.10	± 0.5	3/8	9.52	73	50.0	30	111	15.0	36	2000	0.4
615 165 138 0	CMD5010	10 - 150	1.475	100	0.20	± 0.5	1/2	12.70	73	47.5	41	121	21.0	41	2000	0.7
615 165 139 0	CMD5050	50 - 700	1.475	1000	1.00	± 0.5	3/4	19.05	100	62.0	57	156	27.5	57	1000	1.2
615 165 140 0	CMD5100	100 -1500	1.475	1000	2.00	± 0.5	1	25.40	143	92.0	90	215	45.0	90	1000	4.0

ST4000 series Static Transducers

SETTING PNEUMATIC NUTRUNNERS, TORQUE-LIMITING WRENCHES...

These static transducers are intended to be secured to a mounting base which can resist the applied torques. They are designed for the tuning of nutrunners (measuring stall or shut-off torque) and torque wrenches (torque-limiting, mechanical or digital reading type) and can be used with any type of **GEORGES RENAULT** measuring unit.

A small joint simulator can be inserted between the transducer and the nutrunner which sets the nutrunner to rotate for a better measurement of the setting torque (see accessories below).

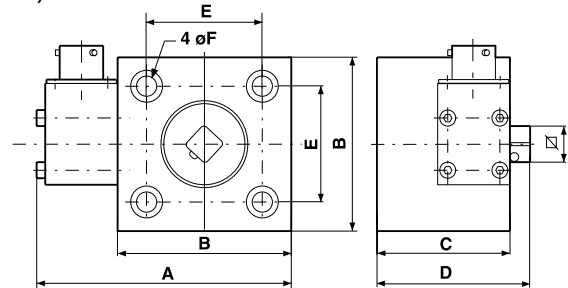

Uncertainty for any type of transducer: \pm (0.3% of the measurement + Linearity)

PART NUMBER	MODEL	TORQUE RANGE Nm	SENSITIVITY mV/V	For Nm	LINEARITY UNCERTAINTY Nm	SQUARE DRIVE		DIMENSIONS (mm)						WEIGHT kg
						Inch	mm	A	B	C	D	E	F	
615 165 141 0	ST4001	1 - 15	1.475	10	0.02	3/8	9.52	88	60	46	53	40	7.0	0.50
615 165 142 0	ST4005	5 - 70	1.475	100	0.10	3/8	9.52	88	60	46	53	40	7.0	0.50
615 165 143 0	ST4010	10 - 150	1.475	100	0.20	1/2	12.70	88	60	46	56	40	7.0	0.56
615 165 144 0	ST4050	50 - 700	1.475	1000	2.00	3/4	19.05	108	80	65	85	60	8.5	3.50
615 165 145 0	ST4100	100-1500	1.475	1000	2.00	1	25.40	108	80	65	90	60	8.5	3.50

Accessories

JOINT SIMULATORS FOR STATIC TRANSDUCERS

These are small joint simulators, consisting of screws and spring washers which are positioned in the square drive of the static transducer. They allow you to set any type of nutrunner to rotate (air shut-off, hydropneumatic, electric nutrunners...) for a better measurement of the setting torque.

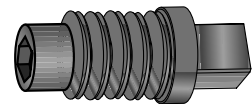

PART NUMBER	MODEL	TRANSDUCER	THREAD	PART NUMBER	MODEL	TRANSDUCER	THREAD	PART NUMBER	MODEL	TRANSDUCER	THREAD
615 910 925 0	ACS3.01	ST4001	M3	615 910 928 0	ACS6.05	ST4005	M6	615 910 932 0	ACS10.10	ST4010	M10
615 910 926 0	ACS4.01	ST4001	M4	615 910 929 0	ACS6.10	ST4010	M6	615 910 933 0	ACS10.50	ST4050	M10
		ST4005		615 910 930 0	ACS8.05	ST4005	M8	615 910 934 0	ACS12.50	ST4050	M12
615 910 927 0	ACS5.01	ST4001	M5	615 910 931 0	ACS8.10	ST4010	M8	615 910 935 0	ACS16.50	ST4050	M16

CABLES FOR CONNECTING MEASURING UNITS AND TRANSDUCERS

PART NUMBER	MODEL	FUNCTION	LENGTH m	CONNECTOR TYPE	CABLE TYPE	MESURING UNIT END	TRANSDUCER END
615 917 251 0	CPNS	Torque	2	6 pt contact pin / 6 pt contact socket	Straight	Torque	Torque
615 917 252 0	CLPNS	Torque	5	6 pt contact pin / 6 pt contact socket	Straight	Torque	Torque
615 917 253 0	CSPS	Torque	0.5 - 2	6 pt contact pin / 6 pt contact socket	Spiral wound	Torque	Torque
615 917 254 0	CCAC	Torque	2	6 pt contact pin / 6 pt contact socket	Straight	Torque & Angle	Torque
615 917 255 0	CLCAC	Torque	5	12 pt contact pin / 12 pt contact socket	Straight	Torque & Angle	Torque
615 917 250 0	CNA	Torque & Angle	3	12 pt contact pin / 12 pt contact socket	Straight	Torque & Angle	Torque & Angle

TUNING AND CHECKING UNIT TO TEST MEASURING EQUIPMENT

The tuning and checking unit can substitute a torque transducer and simulate several sensitivity values to check the correct tuning of torque measuring equipment. This check can be carried out only on the "torque transducer" analog input of the units.

PART NUMBER	MODEL	DIMENSIONS mm	SENSITIVITY mV/V	UNCERTAINTY % value
615 936 007 0	BCE4005	122 x 78 x 56	0.5 - 0.7 - 1.475 - 1.75 - 2	\pm 0.07



General Information



ON THE OVERALL RANGE OF TRANSDUCERS

All **GEORGES RENAULT** transducers are designed to operate – for tightening as well as untightening procedures – within a temperature range from -10° up to $+60^{\circ}\text{C}$ and are fitted with an automatic compensation system against temperature effects. The principle consists in producing an electrical signal, through the intermediary of a wire strain gauge bridge, which is proportional to the distortion of the transducer test piece.

NOTE: The range above the rated capacity must be avoided, as the transducers are likely to exceed their limit of elasticity.

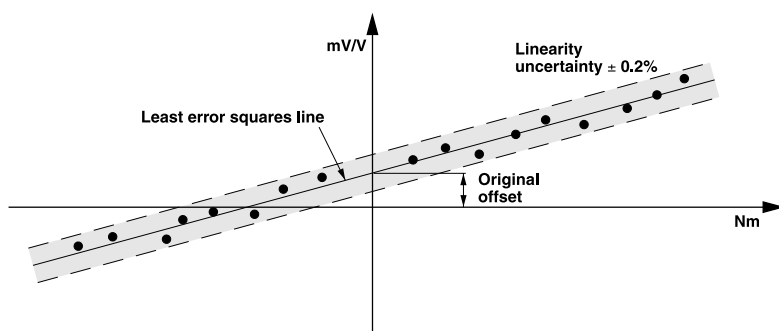

DEFINITIONS:

Linearity: Maximum deviation of the transducer tuning curve from the least error squares line of the points considered. It is a constant value expressed in Nm for the overall capacity rating.

Overall uncertainty: Interval around the measured value within which you are certain to find the actual value. It should be noted that the overall uncertainty of the measuring line is the sum of uncertainties related to the transducer and the uncertainties related to the measuring unit.

A torque transducer is checked and calibrated according to two criteria:

Linearity which is checked against the least error squares line: all the points must be within a defined torque interval (see tables related to transducers) with respect to this line for the transducer to be accepted.

The sensitivity of the transducer which is measured from the least error squares line and is represented by the slope of the line above. The acceptance limit is $\pm 0.3\%$ of the theoretical sensitivity.

Transducer tuning bench

Our torque balance for the tuning of torque transducers is located in an air-conditioned room. The magnitudes associated to the torque (length and weight) as well as the equipment necessary for measuring the electrical signal are strictly monitored and compared with national standards by the Bureau National de Métrologie (BNM) and the Laboratoire National d'Electricité (LNE). A tuning certificate showing the traceability of our equipment is issued with each transducer.



CONNECTIONS

TORQUE TRANSDUCERS

Connections

- A : + Power supply
- B : - Power supply
- C : + Measurement
- D : - Measurement
- E : Weight
- F : Automatic decimal point

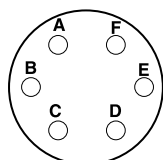

The automatic switching of the decimal point is only used with the former generations of measuring units (such as CMC2001).

TORQUE & ANGLE TRANSDUCERS

Connections

- A : Clock
- B : Count up / count down
- C : + 5 Volts
- D : 0 Volt
- E : Not connected
- F : Not connected
- G : Weight
- H : Decimal point
- J : + Transducer power supply
- K : - Transducer power supply
- L : + Measurement
- M : - Measurement

