



Distributed by  
**LOUZAMPINI**  
& ASSOCIATES  
www.PneumaticToolsOnline.com

For More Info or to  
place an order call us:  
**1-800-353-4676**  
(401-354-8878 international)

*Desoutter*



**Industrial** Tools



- ▶ **Lithium-Ion battery**
- ▶ **Brushless motor**
- ▶ **Torque : 0.4 to 12 Nm**
- ▶ **Speed : 300 to 1550 rpm**



**E-LIT series**  
Desoutter Cordless fastening tools

# Benefits

Improve your efficiency...



## Productivity

### Brushless motor

- ▶ No brush to replace
- ▶ Lower maintenance
- ▶ Longer tool lifetime
- ▶ Faster speed

### Lithium-Ion battery

- ▶ 70% higher energy
- ▶ 65% longer tool use time
- ▶ Recharge at any time without memory effect



## Flexibility

### Easy to use speed setting module (ELS versions Only)

- ▶ The optimal speed for your assembly
- ▶ Speed adjusted in 10 sec.
- ▶ Digital display



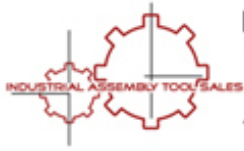

Distributed by  
**LOUZAMPINI & ASSOCIATES**  
 www.PneumaticToolsOnline.com

For More Info or to place an order call us:  
**1-800-353-4676**  
 (401-354-8878 international)

...without compromising quality

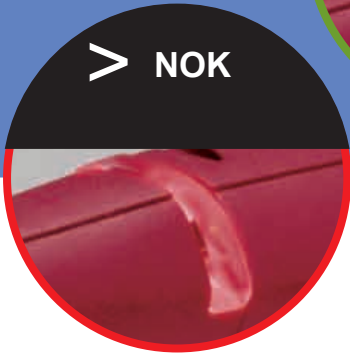
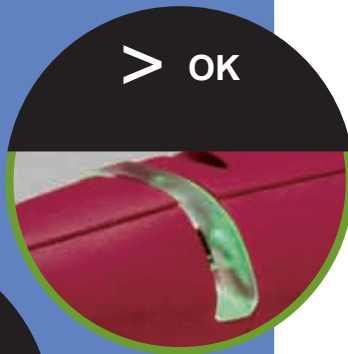

## Process verification

- ▶ Assurance using visual OK/NOK LED's for operator
- ▶ Audible signal for NOK results
- ▶ Tamper proof torque adjustment
- ▶ Re-hit protection
- ▶ Low battery warning
- ▶ Autonomy battery level



## Ergonomics

- ▶ Designed by ergonomists
- ▶ 2 battery positions for balance and application access
- ▶ One touch reverse function

2 models to choose from	 Brushless Motor	 Li-Ion battery	 Speed module
<b>E-LIT premium</b> <i>Electronic brushless speed control (ELS)</i>	✓	✓	✓
<b>E-LIT plus</b> <i>Electronic brushless (ELB)</i>	✓	✓	✗

# Technical features

## E-LIT series

### Advanced technology

30 years of experience on design and gears

#### 1 Brushless motor

(ELS or ELB versions only)  
Wear free  
Maintenance free  
Quieter operation



#### 2 Lithium-Ion

Very fast charging time  
30 min for 1.3 Ah battery  
60 min for 2.6 Ah

**NO MEMORY EFFECT**

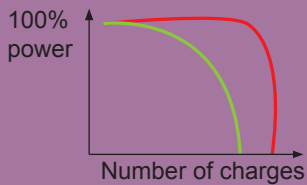

Comparison of battery lifetime

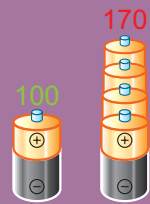

Ni-Mh 100 Li-ion 170  
Comparison of total performance

### Quality assurance

#### 3 Tamper proof torque adjustment

**PATENT**

#### 4 Battery charge level

Visual battery gauge signal				
				100%
				75%
				50%
				25%

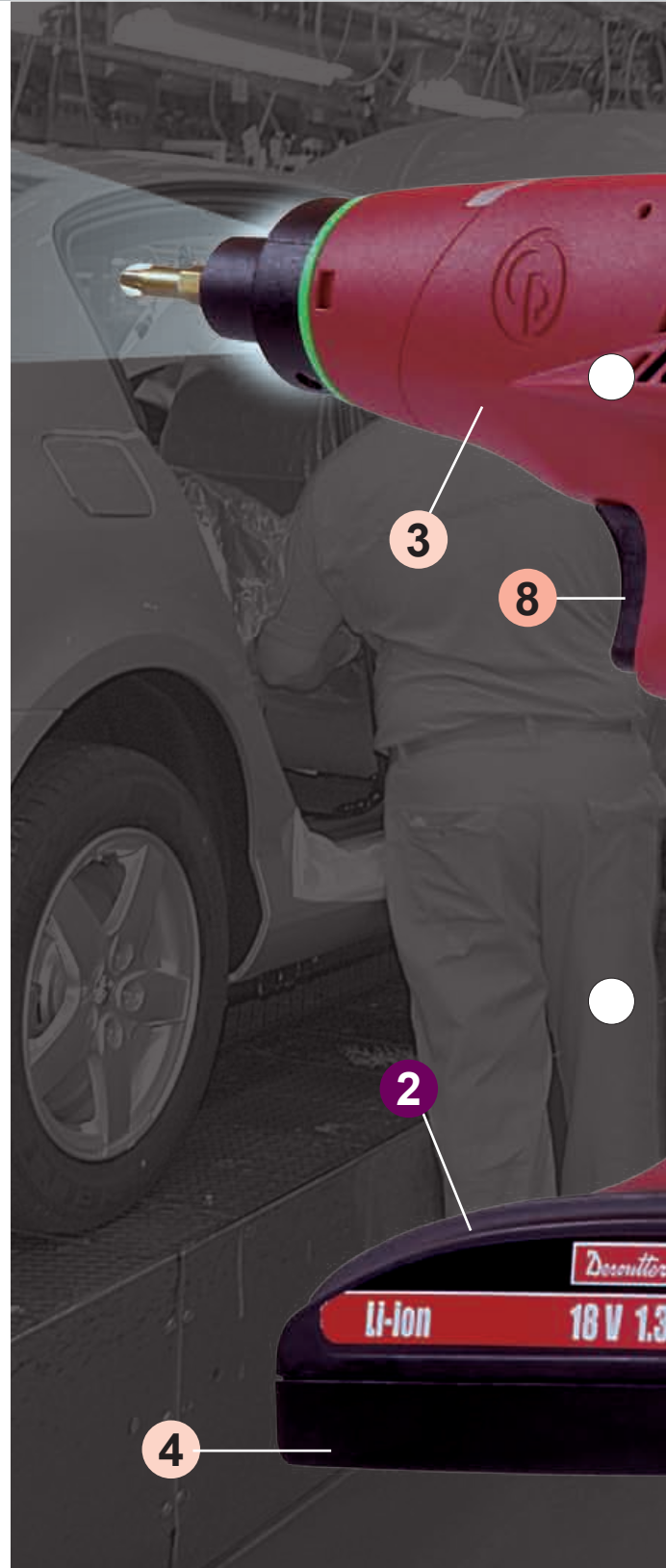



Distributed by

**LOUZAMPINI  
& ASSOCIATES**

www.PneumaticToolsOnline.com

For More Info or to  
place an order call us:

**1-800-353-4676**

(401-354-8878 International)

*Move & Tighten accurately with the most  
advanced electronic technology*

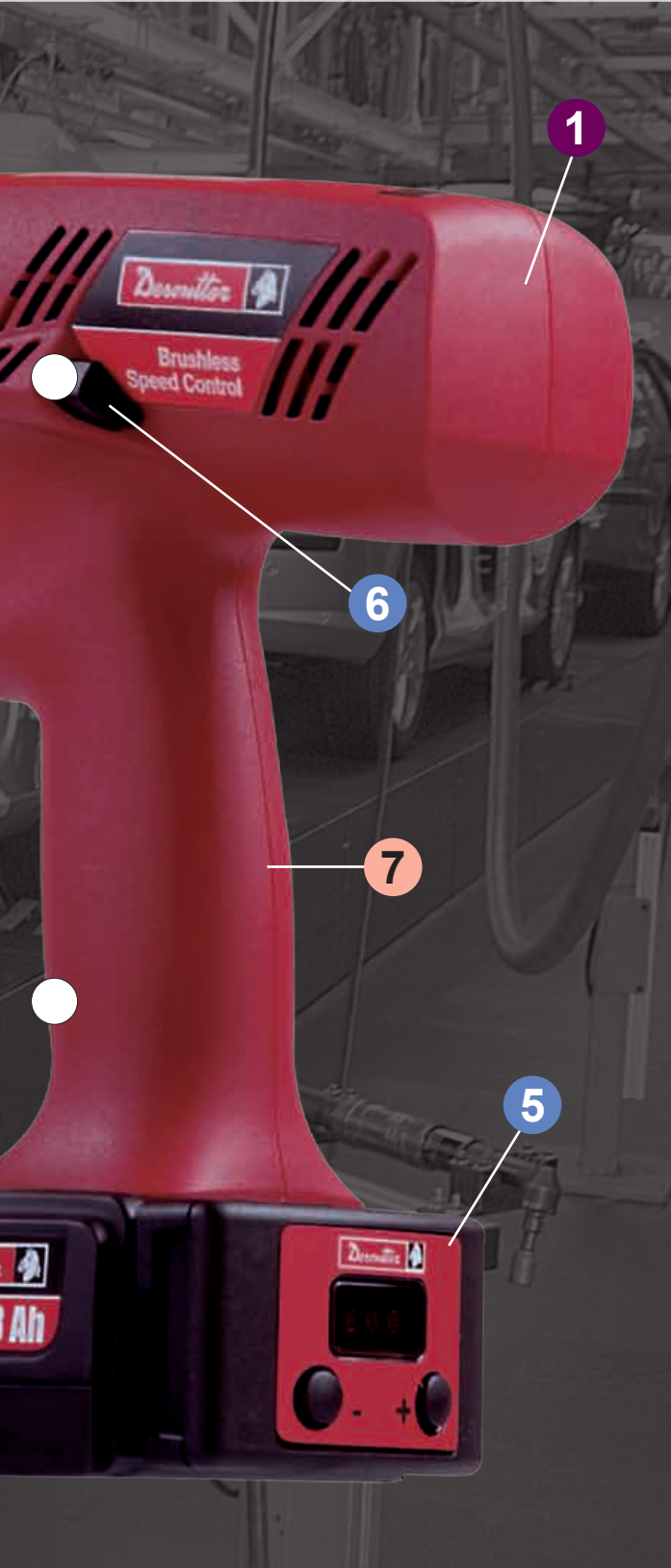

## Innovative

### 5 Speed Setting Module (ELS versions only)

**PATENT**

Optimal speed for application  
Immediate setting  
Only 1 module for all tools



**UNIQUE  
FEATURE**

from 300 to 1550 rpm

### 6 One touch reverse function

**PATENT**

## The best ergonomics

### 7 Perfectly balanced grip design

Designed by ergonomics  
2 battery positions for balance and application  
access



### 8 Non-contact triggers

Soft and easy touch  
One hand operation  
Maintenance free

**Desoutter**



# E-LIT series - Brushless versions

0.4 to 12 Nm (0.3 to 8.8ft.lb) - 300 to 1550 rpm

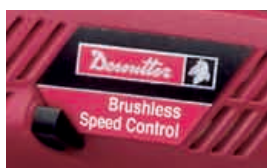

A



B

PIC REF	MODEL	PART NUMBER	TORQUE RANGE		ROTATIONAL SPEED	OUTPUT DRIVE	HEIGHT WITHOUT BATTERY		WEIGHT WITHOUT BATTERY	
			Nm	ft.lb			mm	in.	kg	lb.

## E-LIT - Electronic brushless speed control (ELS)

A	ELS2.5-1550-P	615 165 419 0	0.4 - 2.5	0.3 - 1.8	500 - 1550	Hex. 1/4F	178	7	0.8	1.76
A	ELS6-1000-P	615 165 420 0	0.8 - 6.0	0.6 - 4.4	300 - 1000	Hex. 1/4F	178	7	0.8	1.76
A	ELS8-800-P	615 165 421 0	1.5 - 8.0	0.3 - 1.8	300 - 800	Hex. 1/4F	178	7	0.8	1.76
A	ELS12-600-P	615 165 422 0	3.0 - 12.0	0.6 - 4.4	300 - 600	Hex. 1/4F	178	7	0.8	1.76

## E-LIT - Electronic brushless motor (ELB)

B	ELB2.5-1250-P	615 165 415 0	0.4 - 2.5	0.3 - 1.8	1260	Hex. 1/4F	178	7	0.8	1.76
B	ELB6-900-P	615 165 416 0	0.8 - 6.0	0.6 - 4.4	910	Hex. 1/4F	178	7	0.8	1.76
B	ELB2.5-670-P	615 165 439 0	0.4 - 2.5	0.3 - 1.8	670	Hex. 1/4F	178	7	0.8	1.76
B	ELB6-670-P	615 165 440 0	0.8 - 6.0	0.6 - 4.4	670	Hex. 1/4F	178	7	0.8	1.76
B	ELB8-670-P	615 165 417 0	1.5 - 8.0	1.1 - 5.9	670	Hex. 1/4F	178	7	0.8	1.76
B	ELB12-600-P	615 165 418 0	3.0 - 12	2.2 - 8.8	600	Hex. 1/4F	178	7	0.8	1.76

## How to order standard screwdriver package

- 1 Specify screwdriver model & part number
- 2 Choose battery type & quantity
- 3 Choose charger suitable for local voltage

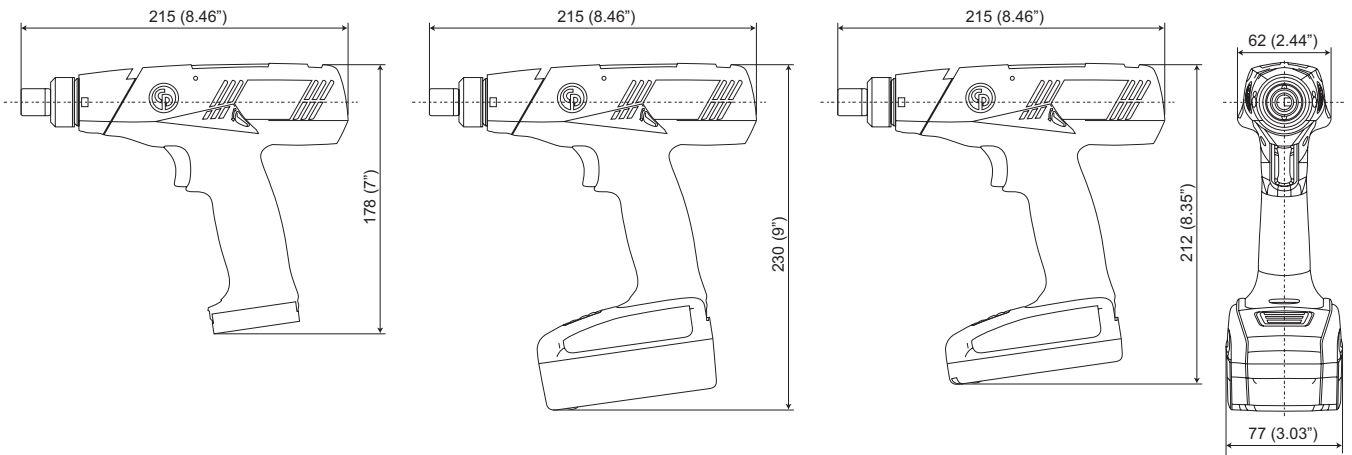

## OPTIONAL ACCESSORIES

ITEM	PART NO.
. Adjustment screwdriver includes with the tool	205 050 785 3

### Battery type

1 Li-ion Battery 18V 1.3 Ah - 0.35 kg (0.77lb)	615 396 748 0
2 Li-ion Battery 18V 2.6 Ah - 0.60 kg (1.32lb)	615 396 749 0

### Charger

3 Charger for Li-ion 230V - Europe	615 396 889 0
3 Charger for Li-ion 120V - USA	615 396 891 0
3 Charger for Li-ion 230V - UK	615 396 890 0

### Miscellaneous

4 Speed setting module (ELS version only)	615 396 829 0
5 Side handle	615 396 757 0
6 Cover protection	615 396 870 0
7 Battery cover protection for battery 18V 1.3 Ah	615 396 871 0
7 Battery cover protection for battery 18V 2.6 Ah	615 396 872 0
. Suspension bail	615 396 757 0
8 Kit Colour rings (7)	615 396 742 5
. Aluminium case	615 995 630 0



[www.cp.com](http://www.cp.com)



Please find local contact at: [www.cp.com](http://www.cp.com)



Chicago  
Pneumatic

*Desoutter*

GEORGES  
RENAULT

SCANROTOR

*techmotive*

*RediPower*



Distributed by

**LOUZAMPINI  
& ASSOCIATES**

[www.PneumaticToolsOnline.com](http://www.PneumaticToolsOnline.com)

For More Info or to  
place an order call us:

**1-800-353-4676**

(401-354-8878 international)